

MegaTronMR

Touch Screen Controller

Installation Maintenance Repair Manual



Advantage Controls
4700 Harold-Abitz Dr.
Muskogee, OK 74403
Phone: 800-743-7431
Fax: 888-686-6212
www.advantagecontrols.com
E-mail: support@advantagecontrols.com

10/2024

MegaTronMR Touch Screen Controller Instruction & Maintenance Manual Table of Contents

Contents	Page
I. Introduction.....	3
Model Numbering	3
II. Installation	4
Electrical Wiring.....	4
Box Layout Overview.....	5
Wiring Diagrams	5
A. Relay Card Wiring.....	5
B. System Card Wiring	5
C. Adding pH/ORP BNC Wiring.....	6
D. 4-20mA Output Card Wiring.....	7
III. Front Panel	8
IV System Operation Overview.....	9
Start-Up	9
Calibration	9
V. Menu Navigation.....	10
VI. Maintenance	29
VII. Advantage Controls Limited Warranty.....	30
VIII. Related Items	31

I. Introduction / Model Numbering

The MegaTronMR microprocessor-based controllers are programmable through a front panel touch screen and can be configured to control a wide range of digital and analog inputs in an RO system. Your particular unit's functions can be determined by comparing the units model number to the Model Numbering table listed below.

MegaTronMR units have several base system control functions and unit optional features. Your unit may be supplied with one or more of the features described in this manual. To determine what features apply to your unit check the model number label located on the controller enclosure.

Example:

MR 13 X 62 99 - B 2 B 1 A



Note: A selection must be made for each model number space above.

CARD 1 I/O	
11	6 digital inputs only
12	Permeate cond/temp no probe
13	Perm & feed cond/temp no probes
14	Permeate cond/temp with probe
15	Perm & feed with probes
22	Perm cond/temp & pH no probes
23	Perm & feed plus pH no probes
24	Perm & feed cond w/ probes + pH no probe
32	Perm cond/temp & ORP no probes
33	Perm & feed plus ORP no probes
34	Perm & feed cond w/ probes + ORP no probe
42	Perm cond, pH & ORP no probes
43	Perm & feed, pH & ORP no probes
44	Perm & feed cond w/ probes + pH & ORP, no probes
52	pH & ORP no cond or probe

CARD 1 CONFIGURATION	
A	RO, Inlet, Flush
B	RO, Inlet, Flush, Divert
C	RO, Inlet, Flush, Boost
D	RO, Inlet, Flush, Divert, Boost

CARD 2 & 3 I/O (Card 2 can include card 1 options plus ...)	
99	No card
61	(4) mA outputs*
62	(4) mA inputs*
63	(8) mA outputs*
64	(8) mA inputs*
65	(4) mA inputs and outputs*

RELAYS (2.5 amp each)	
A	(5) 120-240 VAC, no din rail wiring
B	(5) with din rail connectors wired
C	(10) 120-240 VAC, no din rail wiring
D	(10) with din rail connectors wired

POWER	
1	120 VAC incoming power
2	120 VAC, UL, CSA, CE labeling
3	240 VAC incoming power
4	240 VAC, UL, CSA, CE labeling

COMMUNICATIONS	
A	WebAdvantage ability, no admin rights
B	WebAdvantage with administration rights**
C	WebAdvantage no rights & Bacnet TCP/IP
D	WebAdvantage with rights & Bacnet TCP/IP**
E	WebAdvantage no rights & Modbus TCP/IP
F	WebAdv with rights & Modbus TCP/IP**

FLOW METER (PULSE) INPUTS	
1	No inputs
5	(5) inputs

BOX	
A	14" x 12" x 8" poly
B	16" x 14" x 8" poly
C	18" x 16" x 10" poly
D	12" x 10" x 6" poly (relay option A or B req.)
X	Box defined in motor control



*Note: Option 61, 63, and 65 cannot be used on card 3 if option 61, 63, or 65 have been used on card 2.

**Note: Option B, D or F are required to obtain free WebAdvantage access and administrative rights to the controller. Internet connectivity must be obtained / provided separately and involve cost.

II. Installation

Electrical Wiring

The MegaTron MR controller has an internal regulated fused power supply that will operate off of 90 to 250 VAC at 47 to 63 Hz on the incoming wiring. Each output relay is individually protected with a replaceable 2.5 amp fuse. Relay outputs will equal incoming line voltage.

 CAUTION 
1. Low voltage signal wires (probes, flow switch, water meter, etc.) should never be run in conduit with high voltage (like 115VAC) wires.
2. Never attempt to land connections to the controller without first disconnecting power from the outlet.
3. Do not block access to disconnect power during mounting and installation.
4. The controller should be connected to its own isolated circuit breaker, and for best results, the ground should be a true earth ground, not shared. Any attempt to bypass the grounding will compromise the safety of users and property.
5. The electrical installation of the controller must be performed by trained personnel only and conform to all applicable National, State and Local codes.
6. Operation of this product in a manner not specified by the manufacturer may result in damage to equipment or persons.
7. Avoid mounting in locations that expose the controller to direct sunlight, vapors, vibration, liquid spills or extreme temperatures; less than 0°F (-17.8°C) or greater than 120°F (50°C). EMI(electromagnetic interference) from radio transmissions and electric motors can also cause damage or interference and should be avoided.

NOTES:

1. Units should be ordered with the appropriate option to provide powered relays designed for the incoming/outgoing power.
2. Do not drill holes in upper section of enclosure.
3. All relays provide a N.O. and N.C. output.
4. The control function that activates each relay output is pre-configured at the factory based on the options selected. To change relay activation, see on page 24.
5. Refer to label inside lower panel cover for specific relay board configuration supplied.
6. Relays configured as “dry contact” should only have D.C. voltage ran through them. The GND connection point replaces the NEU when configured for dry contact. (Example: Use GND and N.O. for a normally open dry contact relay output.)

 **WARNING:** If jumpers are not configured for dry contact, line voltage will be supplied.

Box Layout Overview

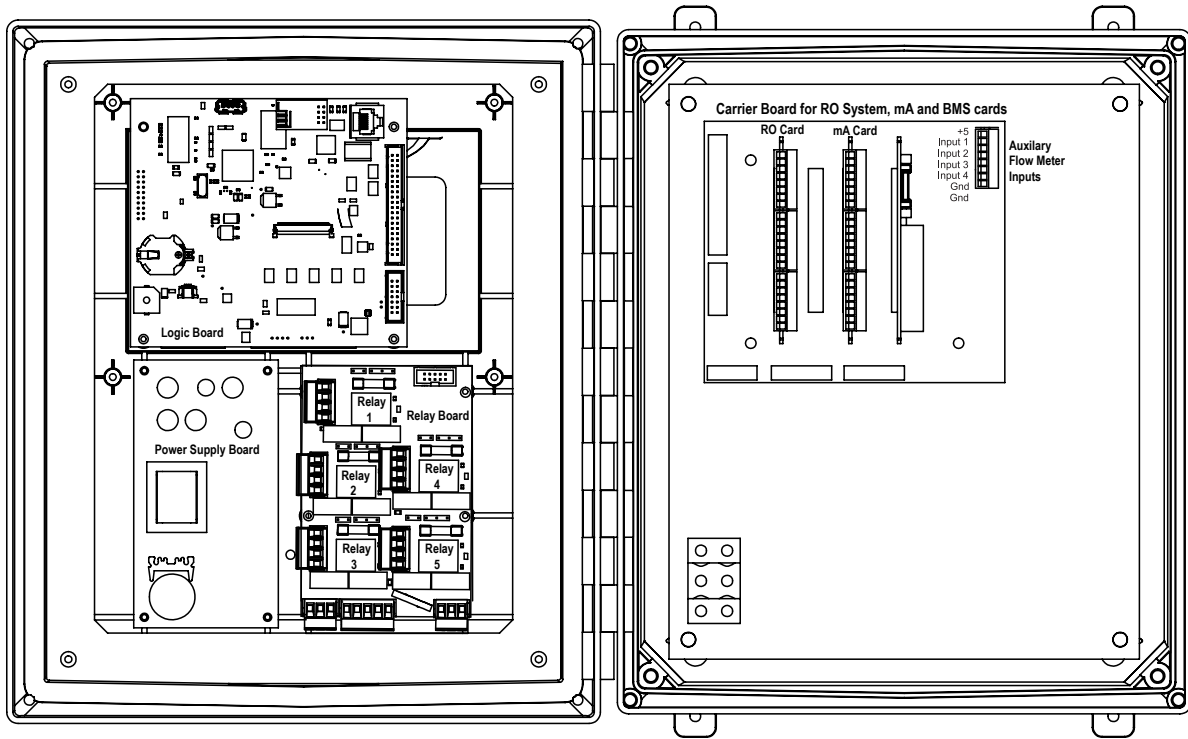

Wiring Diagrams

Relay Card Wiring

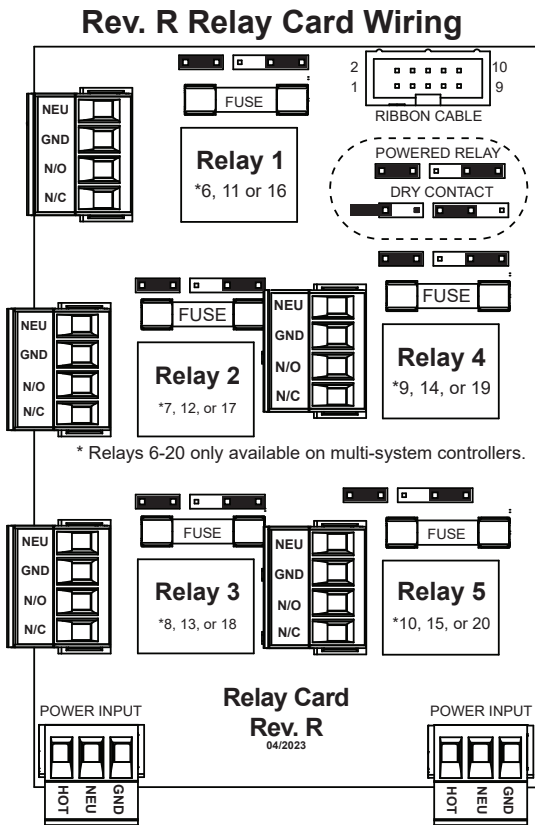

System Card Wiring

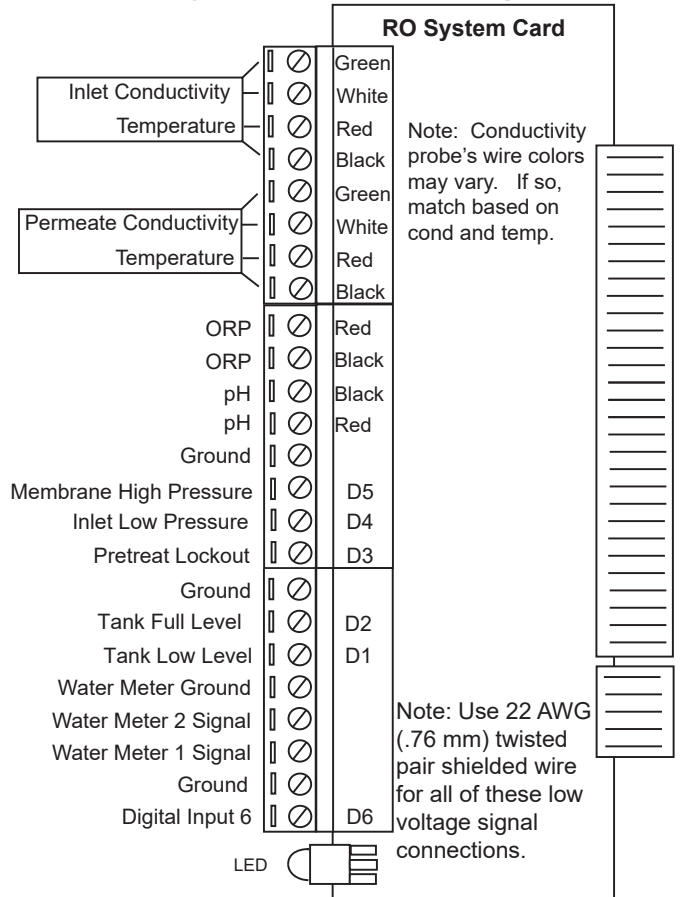

Adding pH/ORP BNC Wiring

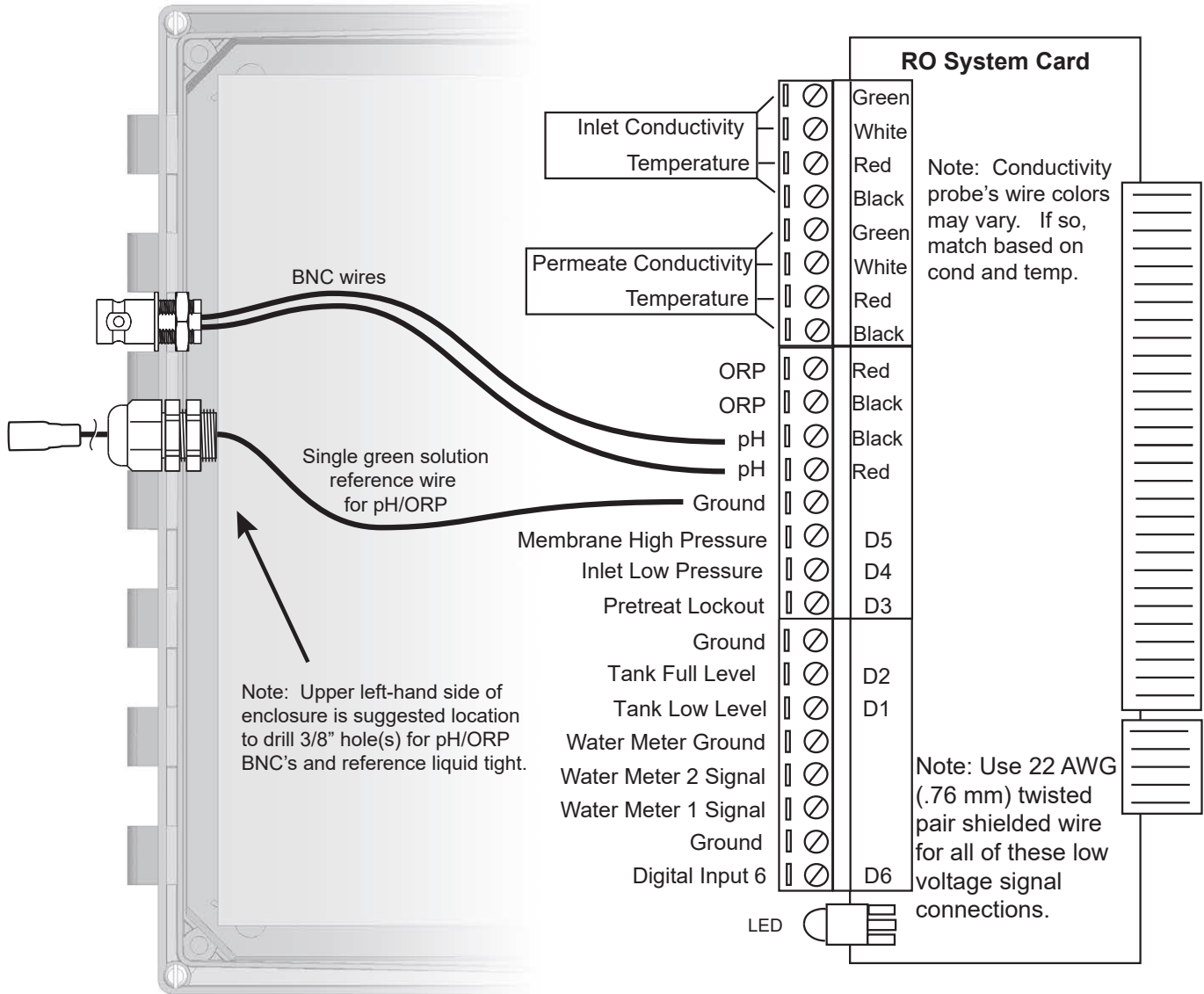

4-20mA Output Card Wiring

A. Isolated Configuration

For isolated 4-20mA outputs an external power source for the loop must be supplied. JP4 and JP5 on the board must be jumpered for isolated, with an external power source supplied to the external VDC input. The external power source must not exceed 24 volts DC.

B. Non-isolated Configuration

For non-isolated 4-20mA outputs the controller will supply the power for the loop. JP4 and JP5 must be jumpered for non-isolated, and no connections are made to the external VDC points.

NOTE: The power for the mA output loop is always provided by the controller with either isolated or non-isolated configuration.

4-20mA Input Card Wiring

The 4-20mA input card requires that the external device sending the 4-20mA input signal(s) supply the power for the loop. The external power source must not exceed 24 volts DC.

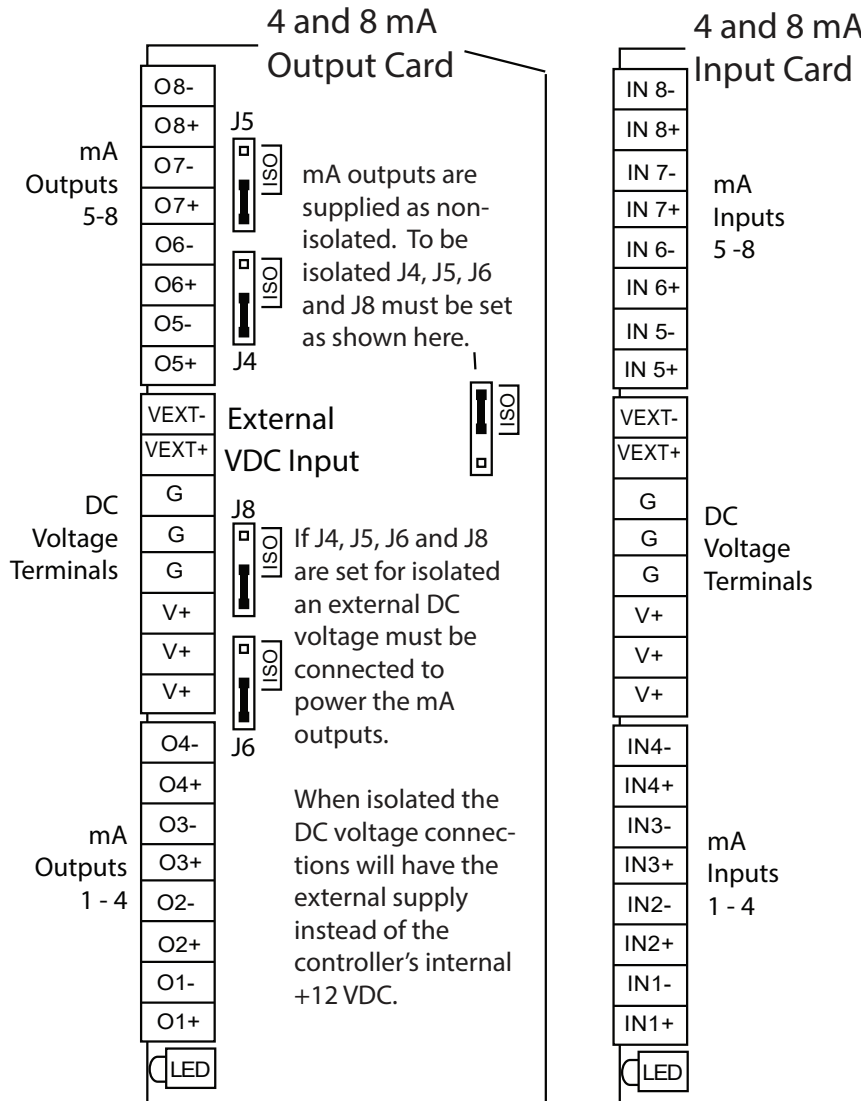

III. Front Panel Description

The screenshot displays the ACI MEGATRON control panel interface. At the top, there are navigation buttons for UP and DOWN, the system name 'ACI MEGATRON', the date and time 'Friday March 15, 2024 0:04:09 Wk2', a HELP button, and a Setup/Run button. The main display area is divided into several sections:

- RO SYSTEM:** Shows 'AUTO: OFF'.
- SYSTEM STATUS:** Shows 'OFF'.
- Water Quality Parameters (Left Panel):**
 - COND1 TEMP1: 0 uS/cm, 32.0 F
 - COND2 TEMP2: 0 uS/cm, 32.0 F
 - PH WM1: 0.7 pH, 0.0 Gal
 - ORP WM2: -1045.7 mV, 0.0 Gal
- Operational Metrics (Green Panel):**
 - Current ON time: 00:00:00
 - Accumulated RUN time: 00:00:00
 - Flush OFF: 00:00:00
- Alarms (Table):**

DIN:	TANK LOW	OK
DIN:	TANK HIGH	OK
DIN:	PRETREAT	OK
DIN:	INLET LOW P...	OK
DIN:	MEMBRANE ...	ALARM
R1:	INLET VALVE	OFF
- Bottom Navigation:** Buttons for RELAYS, RO, NC, and HOA. A red warning icon indicates '7 Alarms!'.

- SET UP/RUN - System initializes into RUN mode. Press this key to put the controller in SET UP Mode and see HOME menu page.
- HOME - Used to go back to the HOME menu page.
- HELP - Used to access help screens.
- BACK - Used to go back to last menu screen viewed or clear values keyed in that are not wanted.

The default is the RELAY status menu, but this can be changed by navigating to the desired screen and pressing the HELP button. Follow the on-screen instructions to set the new hot key location.

IV. System Operation Overview

Operation

MegaTronMR controllers have two modes of operation, RUN and SET-UP.

RUN - This mode is for normal operation. In the RUN mode the display will show each system's parameters. If an alarm is present, the ALARM box will flash how many alarms are activated. No settings may be entered or changed in the RUN mode. Readings are updated every 6 seconds on the screen while in the RUN mode.

SET-UP - This mode is used to make adjustments to settings and readings on the controller. To access the SET UP mode from the RUN screen, press the SETUP/RUN key.

Typical Start Up Instruction

Complete all installation steps before beginning this procedure. Ensure that all controlled devices (pumps, solenoid valves, etc.) are operational and connected to the controller. Before beginning the startup procedure, familiarize yourself with the programming and operation of the system by reviewing the menus available. Use the keys of the controller to skim through all your options.

A. Calibration

All MegaTronMR controllers are factory calibrated for temperature, conductivity, pH, and ORP. All units are shipped with the date preset, and the clock set to your current time. These readings and settings should be verified for accuracy, and adjusted as per the instructions listed below.

1. **Conductivity** - To calibrate the conductivity reading, remove the electrode from the line and wipe the flat surface with a clean cloth. Re-install the electrode and open the isolation valves to allow a sample across the probe. Be sure to allow the reading to stabilize for one minute. Select "SYSTEM COND" from the "CALIBRATION" menu. Then key in the corrected conductivity value. Press ENTER to log in that reading.
2. **pH** - Under normal operating conditions, pH calibration is achieved using the following steps. From the "CALIBRATION" menu, select "SYSTEM PH." Enter the correct pH value. Press ENTER to log in the new reading.
3. **ORP** - To calibrate ORP, from the CALIBRATION menu, select "SYSTEM ORP". Compare the displayed reading to the actual system ORP. If these readings do not match, key in the correct ORP value, and push ENTER.

There are limits to how much the calibration can be adjusted. The instrument will only accept new conductivity values which are from 1/3 to 8x the present reading. Any entry outside this range will cause a default to the original reading. If this happens, call 1-918-686-6211 for technical assistance.

V. Menu Navigation

To access the menus, press the Set Up / Run key on the front panel. This takes you to the Home menu. MegaTronMR controller's menus are easily navigated by pressing the associated number key next to a menu box on the screen. Once you have stepped through the sub menus to reach a point at which a value or selection is made, a Pop-up window will appear prompting you to enter a desired value or selection.

NOTE: When entering new numeric values, enter all available digits (characters).

Home Menu

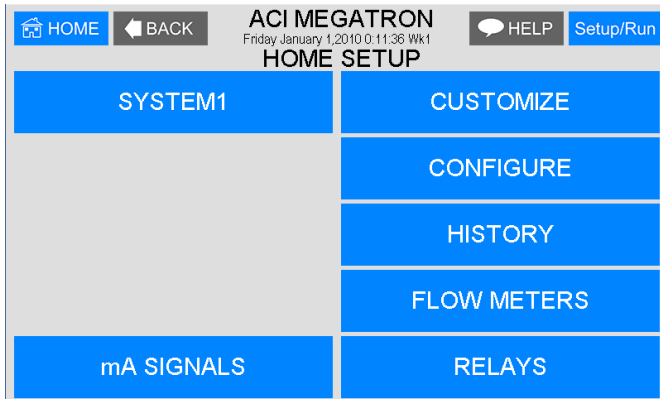

From the **HOME** menu select the desired menu. The menu name explains what parameters can be programmed in the menu.

- SYSTEM1 -** Setting control set points for RO process, conductivity, temperature, pH, and ORP for card 1.
- mA SIGNALS -** Menus for setting mA inputs and outputs calibration and control settings.
- CUSTOMIZE -** Giving the controller, each system, mA input, and all relays a user-defined name.
- CONFIGURE -** Menus for configuring passwords, relay activations, setting history interval, contrast, temperature scale.
- HISTORY -** Allows for view history on board in a graph form.
- FLOW METERS -** Menu for configuring flow meter totalizing.
- RELAYS -** Menu for resetting accumulated "ON" times and manual relay activation.

1. Set Points

The same basic format is used for defining each available analog probe input's control parameters.

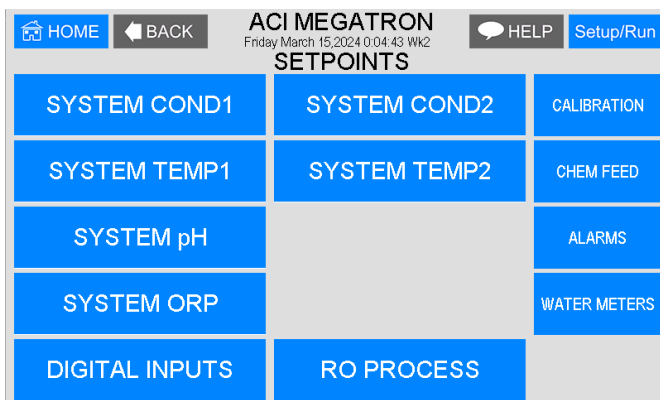

SET POINTS - For setting the relay set points for the available analog probe readings such as RO process, conductivity, pH, ORP, or temperature.

NOTE: In the Setpoint pop-up screen the direction (Rising or Falling) of the setpoint can also be set. Rising setpoints will activate the control relay when the particular probe reading rises above the setpoint and will stay activated until the reading comes down by the amount of the differential. If set for Falling the relay is activated when the probe reading falls below the setpoint and stays on until the probe reading comes back up by the amount of the differential.

1.1 Set Point Options

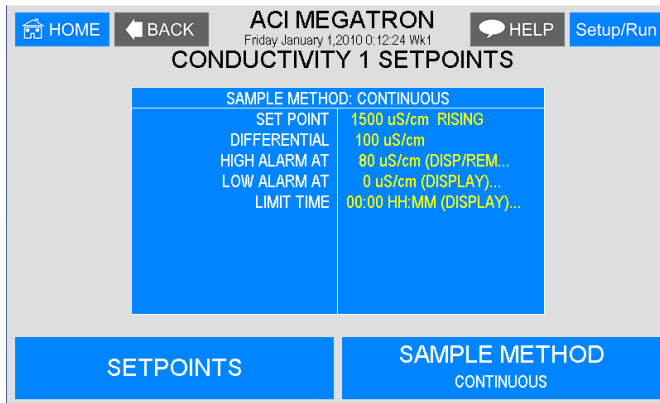

SET POINT - What reading turns the relay on.
DIFFERENTIAL - Amount reading changes by before the relay is turned off
HIGH ALARM - What reading generates a High alarm.
LOW ALARM - What reading generates a Low alarm.
LIMIT TIME - What amount of continuous bleeding will generate a time alarm notice. The bleed is not locked-out by this alarm.

Note: Each alarm value can also be set up to be displayed or not on the front screen, as well as remotely notified or not, if connected to the WebAdvantage server.

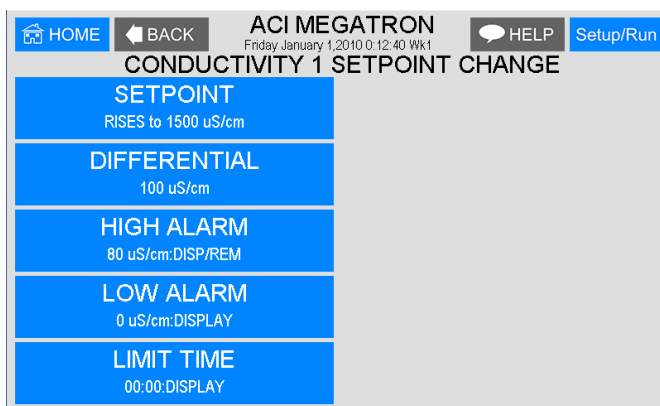

SET POINT - What reading turns the relay on
DIFFERENTIAL - Amount reading changes by before the relay is turned off
HIGH ALARM - What reading generates a High alarm notification.
LOW ALARM - What reading generates a Low alarm notification.

1.2. RO Process Settings

The settings in the RO Process menu define when the RO system is activated and includes Restart rules, Flush settings and more.

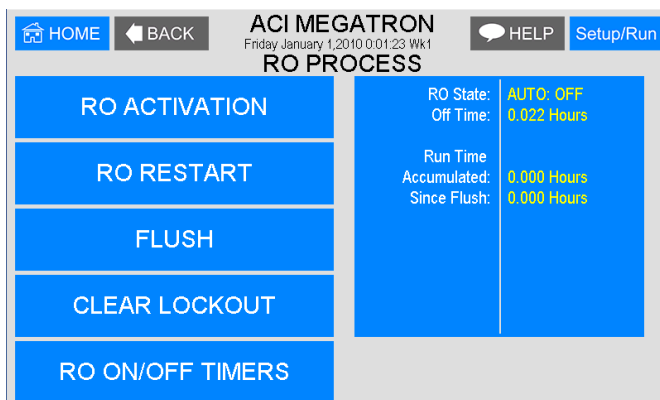

RO ACTIVATION - What activates and disables the RO pump and inlet valve.
RO RESTART - Defines how many times the system will try to restart after being disabled and the delay between restart attempts.
FLUSH - Defines the type, time and sequence for flushing.
CLEAR LOCKOUTS - Allows active lockouts to be cleared.
RO ON/OFF TIMERS - Settings for accumulated run times, alarming and resetting or accumulated run times.

1.2.1. RO Activators and Shut-Offs

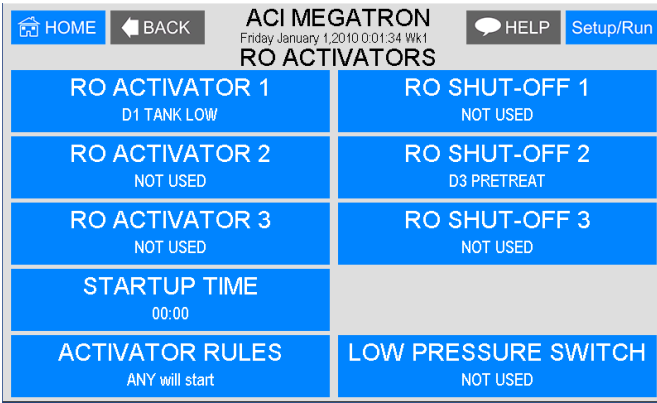

RO ACTIVATOR 1-3 - Defines what will activate the RO like a low tank level or other input. Multiple things can activate the RO but typically only Activator 1 is needed.

STARTUP TIME - The amount of time the inlet valve must be open before the RO pump relay is activated.

ACTIVATOR RULES - Defines rules for activation if multiple activators are in use.

RO SHUT-OFF 1-3 - Defines various inputs or conditions that can shut-off the RO.

LOW PRESSURE SWITCH - Defines which digital or analog input is the low inlet water pressure switch.

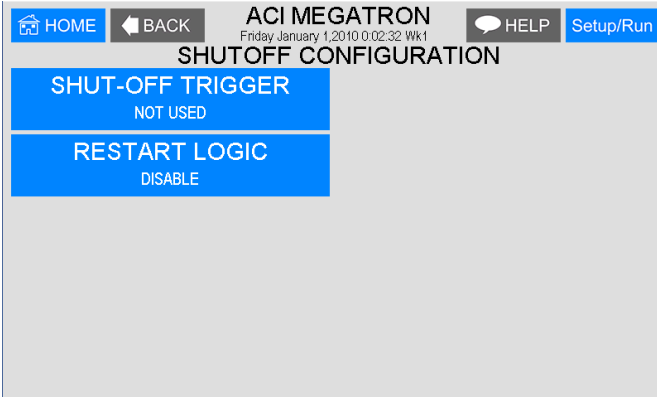

SHUT-OFF TRIGGER - Select a specific input that forces a shut-off.

RESTART LOGIC - Select if a shut-off initiates the restart attempt logic or not.

1.2.2. RO Restart Settings

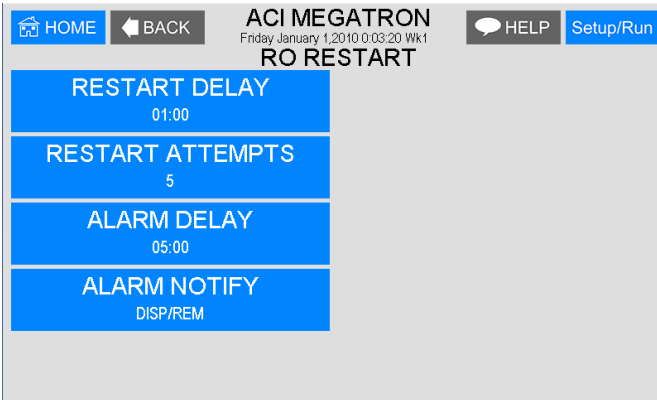

RESTART DELAY - Define the amount of time to wait before attempting to restart the RO after a shut-off has occurred.

RESTART ATTEMPTS - Define the number of attempts to try to restart.

ALARM DELAY - The amount of time to wait before the restart fail alarm is activated.

ALARM NOTIFY - Select if the alarm is to be displayed, send remote notification or not.

1.2.3. RO Flush Settings

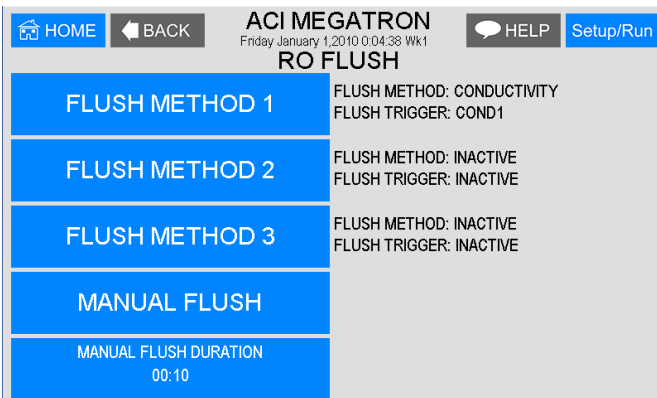

FLUSH METHOD 1-3 - Define 0-3 different triggers for when to do a flush along with the amount of time the flush is to occur.

MANUAL FLUSH - Used to force a manual flush for a specific set of time.

MANUAL FLUSH DURATION - The amount of time for manual flush.

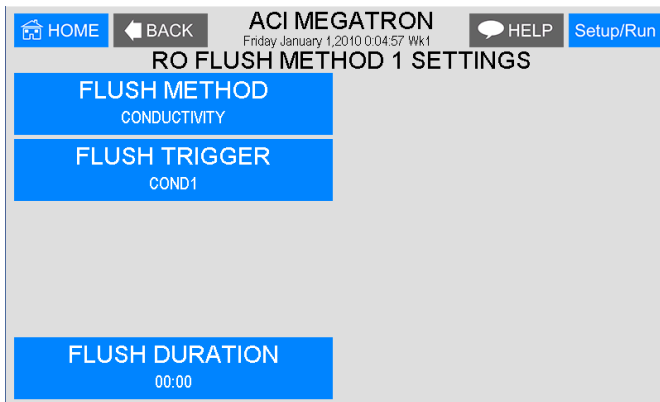

FLUSH METHOD -Define the flush type.
FLUSH TRIGGER- Define the input to use.
FLUSH DURATION - The amount of time for this flush.

1.2.4. RO Run Timers

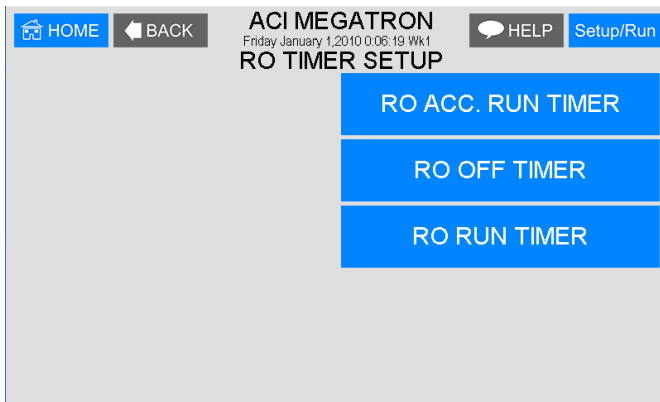

RO ACCUMULATE RUN TIMER - Settings for the amount of accumulated RO run limit time and alarming.
RO OFF TIMER- Alarm settings for consecutive amount of timer the RO has not ran.
RO RUN TIMER - Amount of limit time for and individual RO run event.

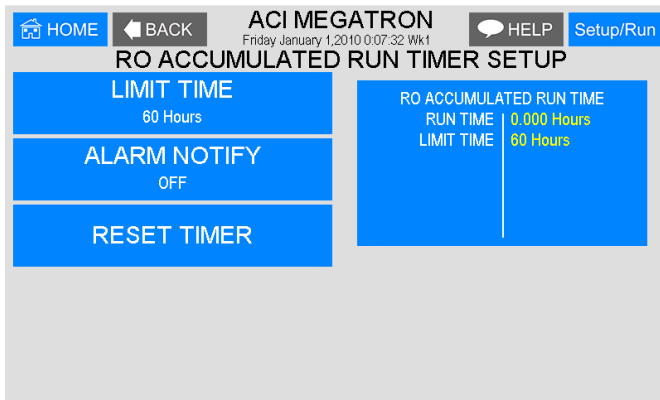

LIMIT TIME - Setting for the accumulated number of run hours to trigger an alarm.
ALARM NOTIFY - Select if the alarm is to be displayed, send remote notification or not.
RESET TIMER - Resets the limit timer's accumulated time.

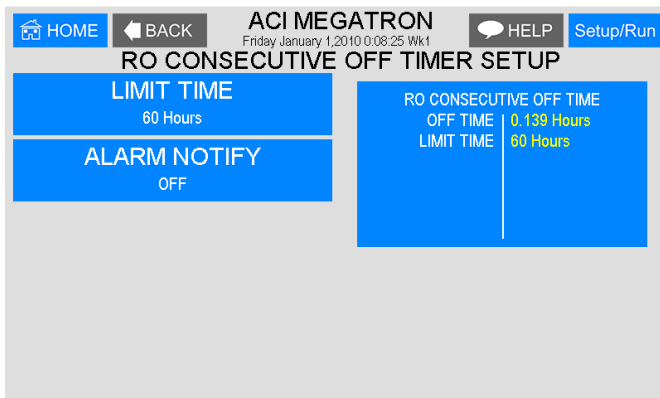

LIMIT TIME - Setting for an individual or consecutive number of off hours to trigger an alarm.
ALARM NOTIFY - Select if the alarm is to be displayed, send remote notification or not.
TIMER - Resets the limit timer's accumulated time.

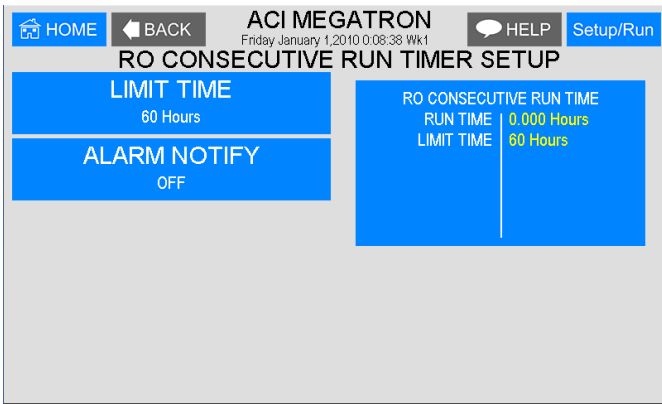

LIMIT TIME - Setting for an individual or consecutive number of on or run hours to trigger an alarm.

ALARM NOTIFY - Select if the alarm is to be displayed, send remote notification or not.

1.3. pH and ORP

The pH and ORP set point settings follow the same format as shown above in section 1.1.

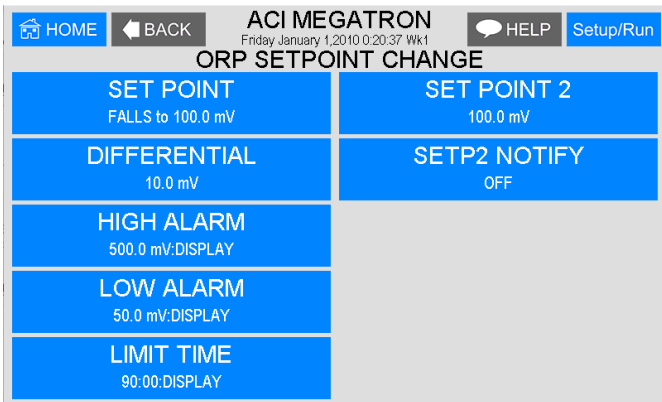

INTERRUPT - Only applies to pH settings and allows the Interruption of pH control during bleed, other chemical feed, or both.

ORP SET POINT 2 - If a 28-day timer is interlocked to ORP, the ORP control will go off of SET POINT 2 during the 28-day timer's run time.

Note: When the Limit Time value is met it will force off the control relay being driven by pH or ORP. To reset the limit timer and get the control relay active again, enter a new Limit Timer value.

1.4. Digital Inputs

Digital inputs are the digital inputs for optional Flow Switch and other digital inputs, such as low drum level alarms. From these menus, alarms, notification, action, and latching settings can be made.

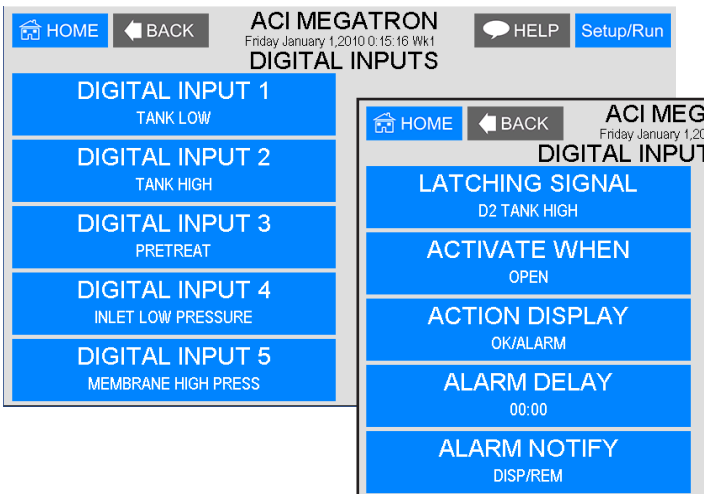

LATCHING SIGNAL - Allows a digital input to stay Active until a second latched input becomes active.

ACTIVE WHEN - Set if input is active seeing closed or open.

ACTION DISPLAY - Set if the input is being set as alarm or just On/Off.

ALARM DELAY - How long input must be in open/closed before registering.

ALARM NOTIFY - Set the alarm notification.

1.5. Calibration

Calibration is for adjusting the displayed value of a probes reading to match your tester or known solution. Pick the system or mA input first. From a particular system, pick the probe to calibrate.

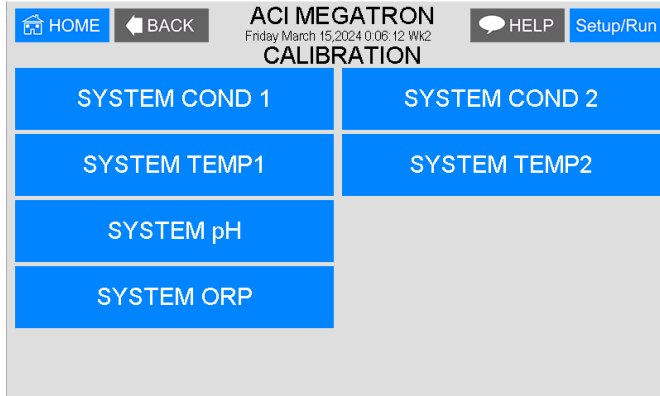

CALIBRATION - For adjusting the actual reading values of the available analog probe inputs, such as conductivity, pH, ORP or temperature.

1.5.1. Conductivity Calibration

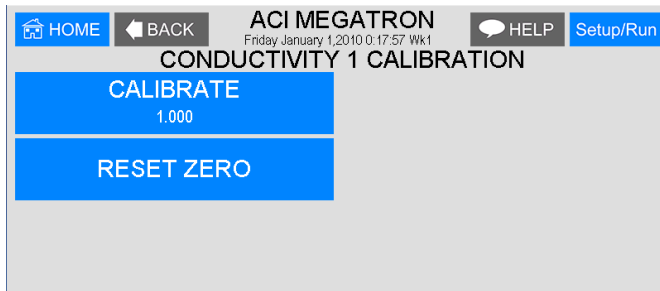

CALIBRATE - With a clean probe on-line seeing the system's water enter the known (tested from a calibrated handheld tester) value.

RESET ZERO - With the probe out of solution and dry, enter a new zero point. **Note:** Probe must be dry!

NOTE: In the calibration pop-up window, the raw analog-to-digital (A/D) value will be displayed. A new calibration value should only be entered when the probe is sensing a stable A/D value. **The A/D reading has a range of 0 to 32,767. If it is at one end of the range or the other when trying to calibrate, something is wrong with the probe or wire run.**

1.5.2. pH and ORP Calibration

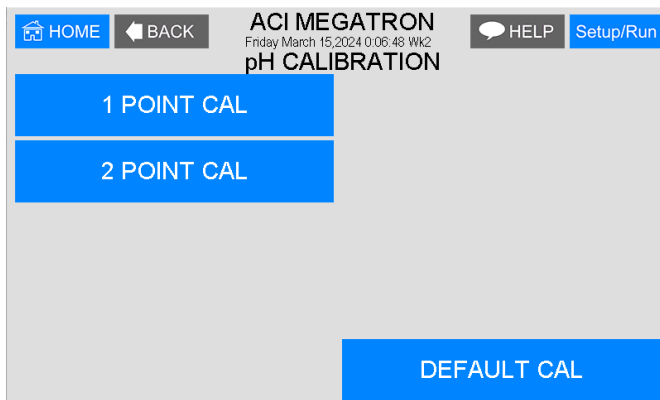

1 POINT - With a clean probe on-line seeing the system's water enter the known (tested from a calibrated handheld tester) value.

2 POINT - Enter a known Low value with a clean probe in a buffer solution. Then enter a known High value with the clean probe in a buffer.

Notes:

1. Probes must be rinsed between buffers when doing a 2 Point calibration and given at least 30 seconds in solution to adjust to the buffer.
2. There must be at least 2 full pH points between buffer solutions. Using a buffer of 4 and 10 is the best procedure. ORP buffers should be at least 200 points apart.

1.6. Chem Feed

A unit may have up to 4 selectable timers for each system on a controller. All timers are associated with their system.

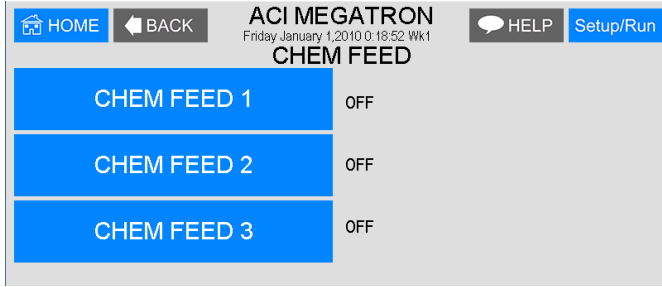

CHEM FEED - Select the type (28-Day, pulse, percent, recycle), as well as the run times of each timer available per system.

1.6.1. Timer Type Selection

A pop-up screen lets you scroll through the various timer types available.

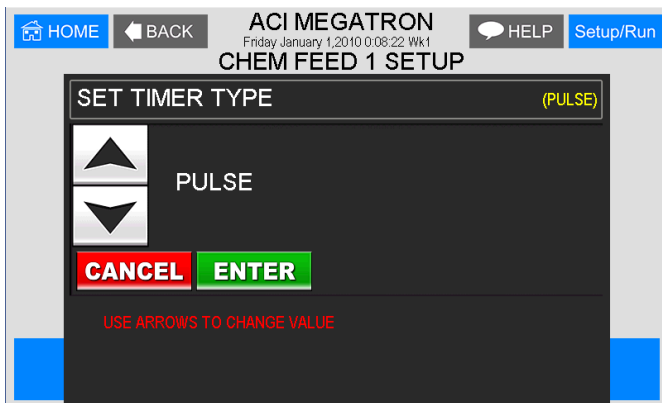

Pulse - A water meter activated timer.

Recycle - A continuous recycle timer with ON and OFF settings.

28-Day - A biocide or event timer.

1.6.2. Timer Set Up

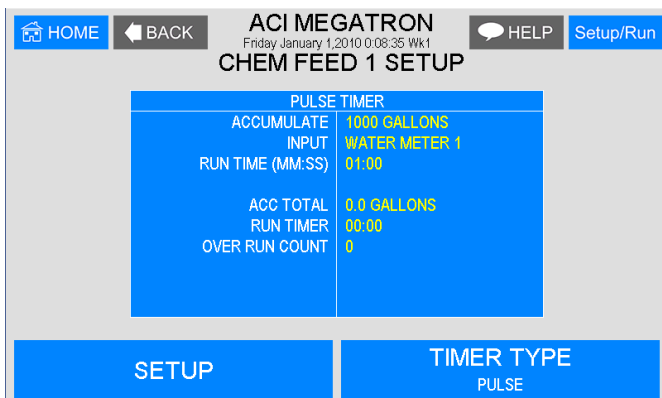

Each timer type selected will have its own unique Set Up submenu with additional selections specific to the type of timer selected. The page displayed before entering the Set Up menu of a timer provides an overall review of the timers current settings.

1.6.3. Pulse Timer

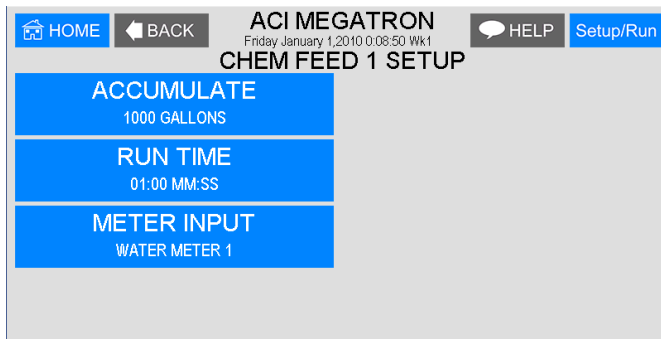

ACCUMULATE - The number of gallons or liters from water meter to count before activating timer.

RUN TIME - The amount of time for the timer to run
METER INPUT - Select water meter 1 or 2 for the timer's activation. Water meter 1 + 2 can be selected only if the meters have the same contact value.

1.6.4. Recycle Timer

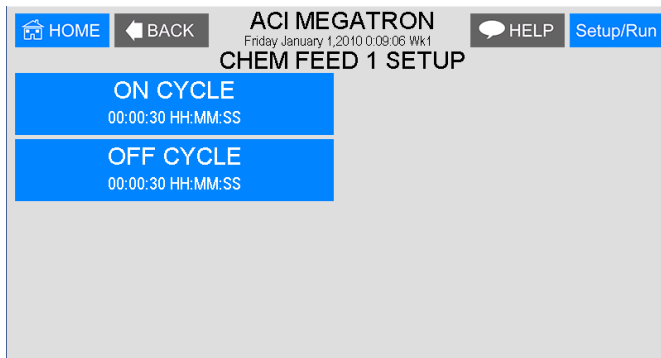

ON CYCLE - The amount of the defined time that the timer is to be on.

OFF CYCLE - The amount of time that the cycle will be off.

1.6.5. 28-Day Timer

Each 28-Day timer has Program 1-4 for programming the various feed times. While the programming steps for four programs are the same, each can have its own independent settings.

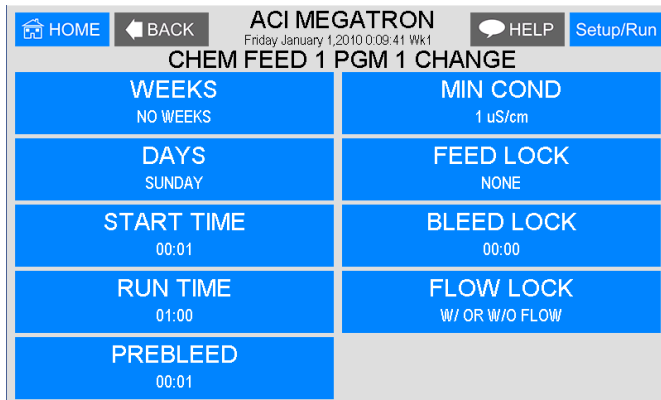

WEEKS - The week(s) that the timer is to feed.

DAYS - The day(s) that the timer is to feed.

START TIME - The time of day for the timer to start.

RUN TIME - How long the timer is to run.

PREBLEED - How long the controller is to bleed down before feeding in chemical. **Note:** The prebleed starts at the START time programmed above.

MIN COND - The minimum conductivity that the unit will prebleed down to.

FEED LOCK - Which other system timer to lockout during this timer's run time.

BLEED LOCK - How long to lock out the bleed function after the timer's run time starts.

FLOW LOCK - 3 selections if a system has a flow switch:

- Only With Flow - If there is no flow at the start time no feed occurs.
- With or Without Flow - Feed occurs regardless of flow condition.
- Flow Only/Store1 - If there is no flow at the start time, one run cycle will occur when flow does come on. Only one run will occur regardless of how many more than 1 are missed due to no flow.

1.7. Alarms

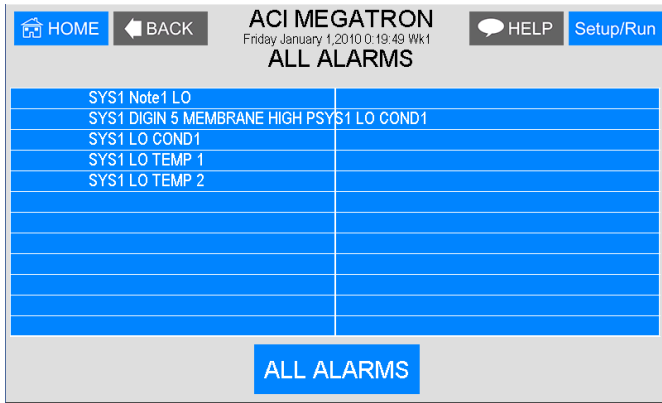

ALARMS - Shows any current alarms. Accessible from the Setup/Run screen.

1.8. Water Meters / Totalizers

Each system will have 2 water meter inputs. Each of these can have the incoming contact defined and track the water usage. A volume alarm can also be defined..

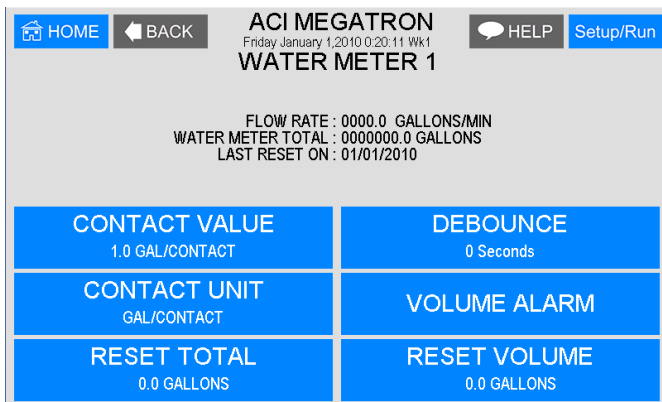

CONTACT VALUE - Defines the numerical value for a contact; i.e. 10.

CONTACT UNIT - Defines the units of measurement for a contact; i.e. Gallons / Contact. If there is a mA input set for a gpm or lpm reading, that mA input can be selected in the Contact Units as the source for the meter input to total flow rate.

RESET TOTAL - Resets the totalizer count.

VOLUME ALARM - Alarm settings for the maximum and minimum volumes for a given period.

DEBOUNCE - An additional amount of time the input will wait before accepting another water meter contact to reduce false contacts from a chattering read switch.

RESET VOLUME - Resets the Volume Alarm totalizer.

2. mA Signals

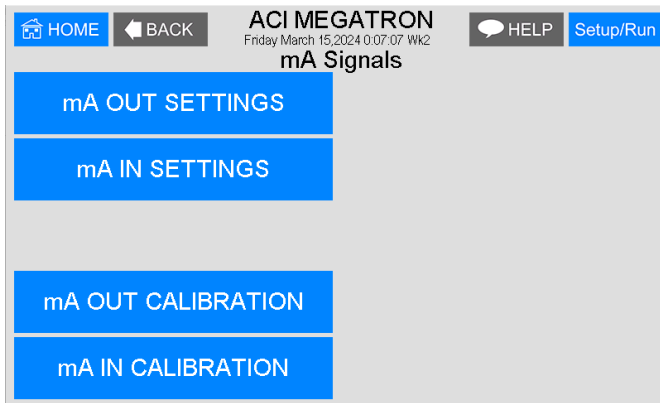

mA OUT SETTINGS - Selecting source and range of outputs.

mA IN SETTINGS - Setting control and alarms for inputs

mA OUT CALIBRATION - Calibrating outputs.

mA IN CALIBRATION - Calibrating inputs and displayed range.

2.1. 4-20mA Out Settings

Units with a 4-20mA output option will have a menu for setting up the 4-20mA output. The 4mA and 20mA values can be defined by giving the output proportioning capability. i.e. 4mA = a pH of 6.0 and 20mA = a pH of 8.0.

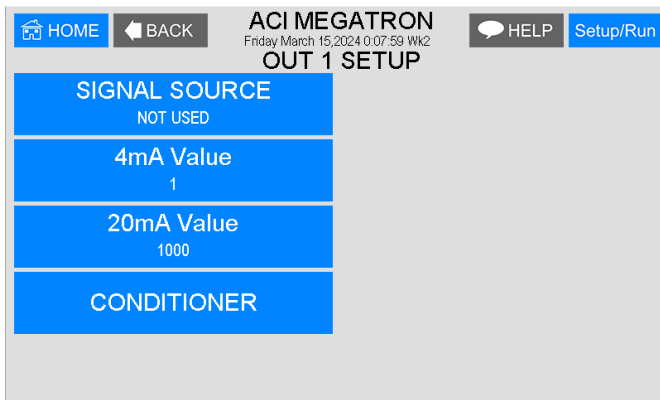

SIGNAL SOURCE - Select which probe reading the mA will use as its reading source.

4 mA VALUE - What the 4mA signal equals

20mA VALUE - What the 20mA signal equals on the assigned signal sources scale.

CONDITIONER - Select a second reading that can change or condition the original mA output.

2.2 4-20mA Input Settings

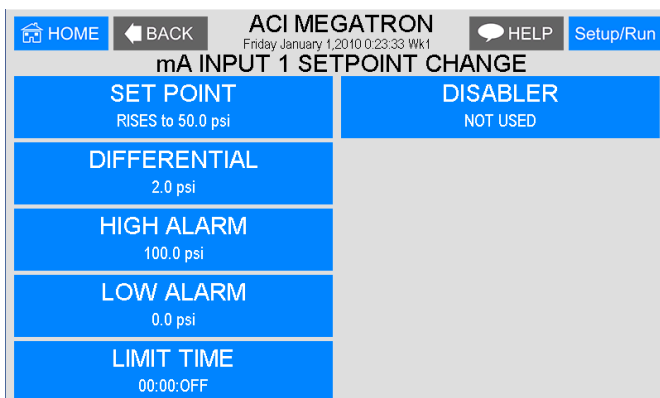

SET POINT - What reading turns the relay on

DIFFERENTIAL - Amount reading changes by before the relay is turned off.

HIGH ALARM - What reading generates a High alarm notification.

LOW ALARM - What reading generates a Low alarm notification.

LIMIT TIME - Setting for an individual or consecutive number of on or run hours to trigger an alarm.

DISABLER - Selected input will disable HIGH/LOW alarm notifications and a control relay being activated by the input's setpoint.

2.3 4-20mA Output Calibration

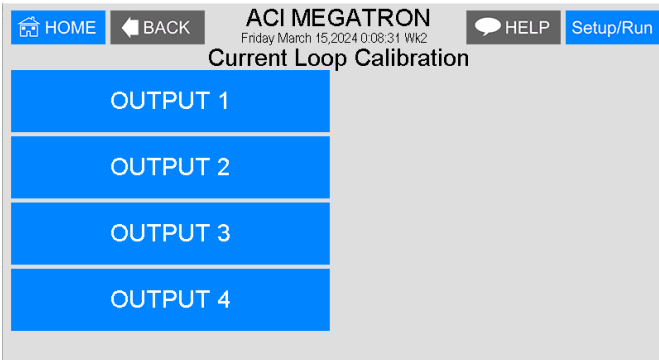

4-20mA outputs can be calibrated to ensure that the output generated by the controller and received by the external device match. With a voltmeter connected across the out and return wires (see page 6) of the 4-20mA output channel, to be calibrated, go into the output's Low or High calibration.

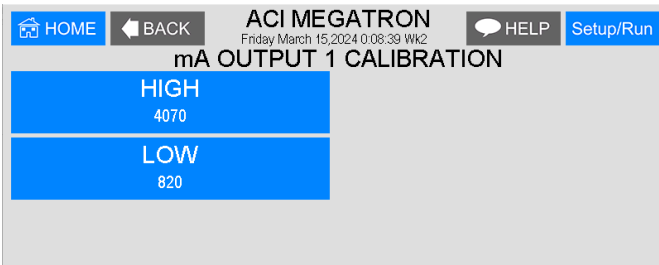

The number displayed in the Calibration dialog box can range from 0-4,095, with 800 equal to 0 mA output, and 4,030 equal to 20 mA. This number range of 0-4,095 is the raw digital-to-analog (D/A) values and is strictly used for reference. The D/A numbers that you get will vary based on your installation conditions.

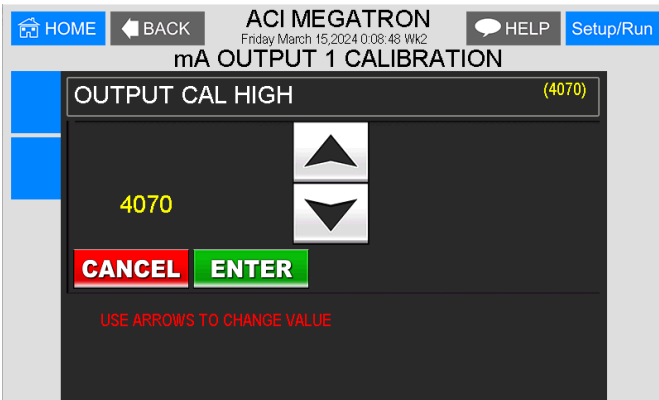

While in the High or Low calibration pop-up screen use the up and down arrows to change the output value being read with the voltmeter. Adjust the High value for the 20-mA reading and the Low value for the 4-mA value.

2.4 4-20mA Input Calibration

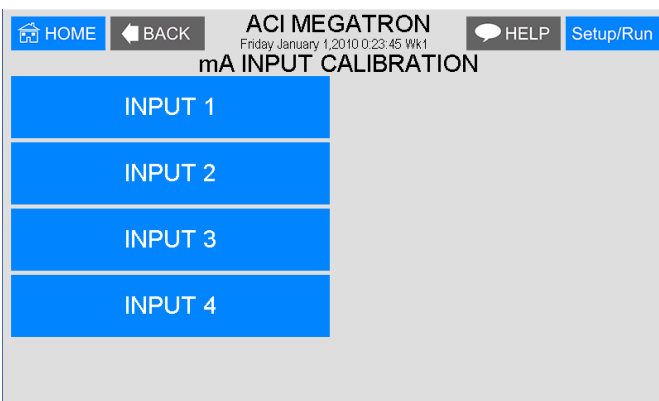

4-20mA inputs can be calibrated to ensure that the input seen by the controller from the external device match. It also allows for setting the 4-20mA input into a number range that relates to the value being read.

Select the Input to be calibrated.

Firmware version MT.16.03 and newer have logic that suspends any control logic if the mA received is 50% below the stored 4mA value. A # will be placed in the RUN screen for any mA value in this invalid state.

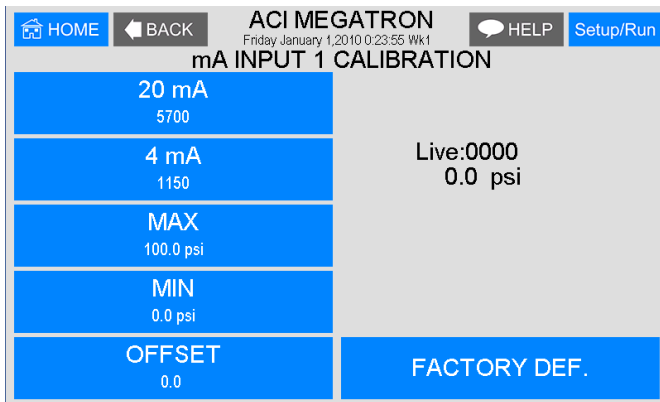

The **20mA** and **4mA** values are where the controller's raw analog to digital value is adjusted to match a 20mA (full scale) and 4mA (bottom of scale) signal from the external device inputting the 4-20mA input. The external device must be connected to the controller and showing either full or bottom of scale when calibrating each. The number shown along with either the 20mA or 4mA while calibrating is the raw A/D value, and is only a reference. A 20mA input should be around 5,500, and 4mA around 1,100. If the A/D numbers are not in this range, check the input device.

If a mA Input is receiving an A/D value 50% below the stored value for 4mA, the reading is viewed as invalid, and control logic is suspended. This is represented on the RUN screen with a #.

The **MAX** and **LOW** calibration inputs define what to display for a 20mA input and a 4mA input. For a drum level sensor on a 55-gallon drum, the value for **MAX** should be 55 and **MIN** should be 0. A number is automatically displayed between 55 and 0 based on the input value. The scale and units of measure (gallons for example) are set in the Customize menu from the Home page. If the decimal position is changed in Customize, all mA input settings and **MIN/MAX** will need to be reset.

OFFSET - Changes the current displayed value of the 4-20mA input reading to allow for a manual 1pt calibration of the displayed value.

FACTORY DEFAULT - If the 20mA or 4mA calibration has been incorrectly set (not at 4 or 20) this will reset the settings back to a factory value for 4 and 20.

3. Customize

This menu allows the user to define the on-screen name of the unit plus the name of each system and relay. The user can also set up the Notepad for each system and 4-20mA Input's name and unit of measurement.

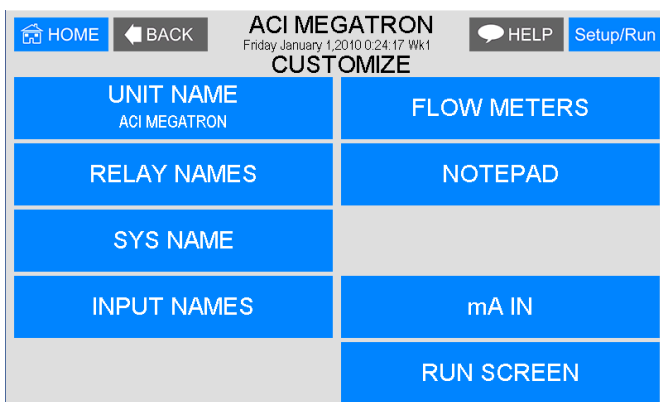

RUN SCREEN - Allows the user to select what will be shown on the screen while the controller is in the RUN mode, such as displaying temperature readings, water meter totals for a particular system, or the conductivity units of measure.

NOTE: When entering values for custom names use the numerical keys for numbers and the up / down arrows to scroll through all the characters of a keyboard. Press the right arrow to advance the cursor after setting a desired value. Press the Help button to place the last entered character into the new cursor space to speed up the process. The Help button will also jump advance through the characters.

3.1 Notepad

The Notepad function allows the user to set up and store manually entered data or perform simple calculations between two different sensor or notepad inputs. There are ten notepad fields per system card and each can be given a custom name, UOM and number range.

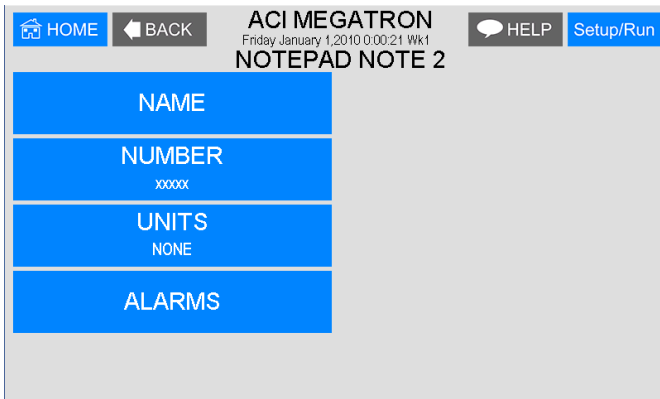

NAME - Pick from a list of defined names or customize your own or if you want the Notepad to be a Calculation.

NUMBER - Set the number range.

UNITS - Set the units of measurement.

ALARMS - Set Hi/Low alarm points and how frequently a new value is expected to be manually entered via the History menu.

If the Notepad is a calculation no time alarm is defined and the calculation results are stored in history at the time stamp interval.

CALCULATION - If a Notepad is to be a calculation select the type of calculation desired.

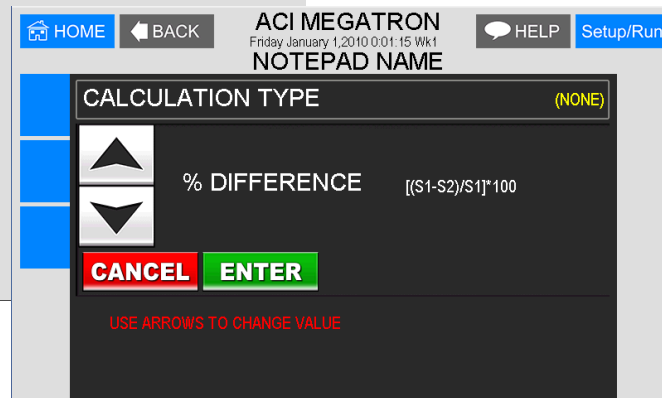
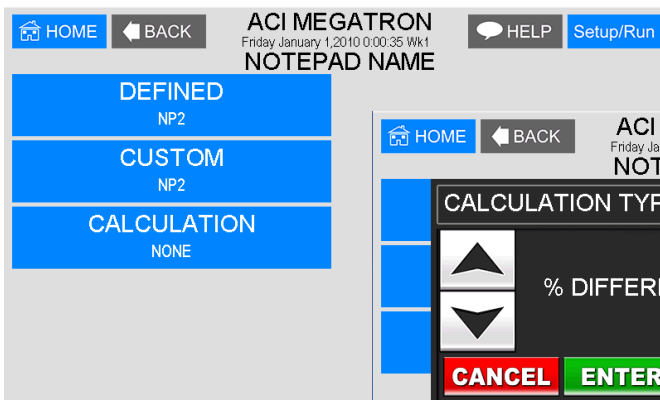

Calculation Types:

- None
- % Increase
- Product
- Total
- Ratio
- % Difference
- Difference

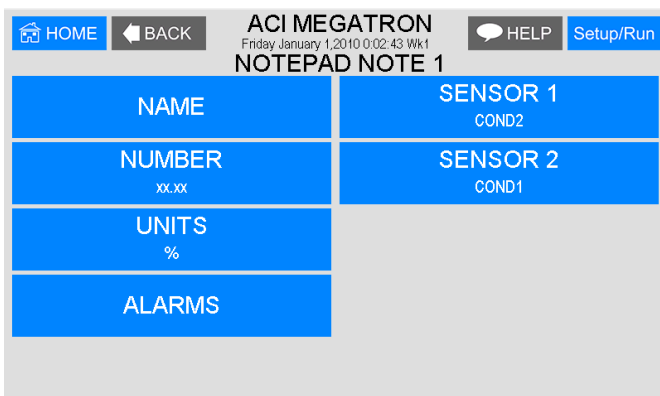

SENSOR 1 - The first sensor reading or Notepad value to be used in the calculation.

SENSOR 2 - The second sensor reading or Notepad value to be used in the calculation.

3.2 mA Inputs

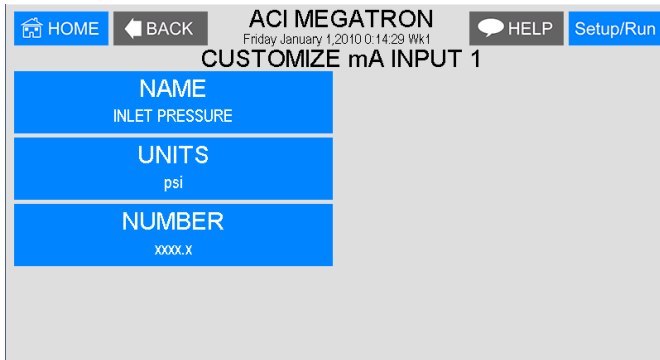

NAME - Name the input.
UNITS - Set the units of measurement.
NUMBER - Set the number range.

3.3 Run Screen

This lets you customize various aspects of the RUN screen.

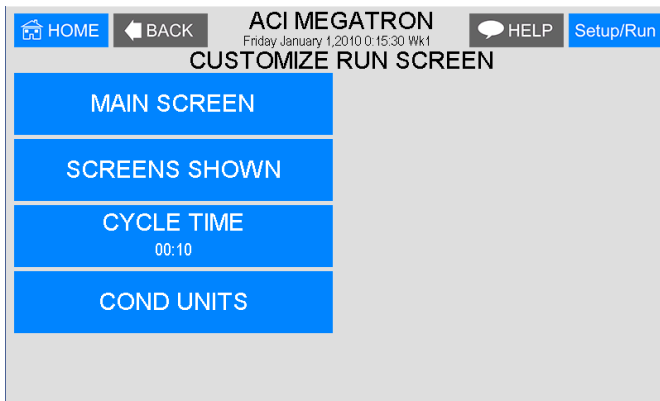

MAIN SCREEN - Customize what is displayed on the RUN screen.
SCREENS SHOWN - Pick if the mA input & Aux Flow screens are scrolled.
CYCLE TIME - The amount of time between screen scrolls.
COND UNITS - Select the units of measure to be displayed with the conductivity reading.

4. Configure

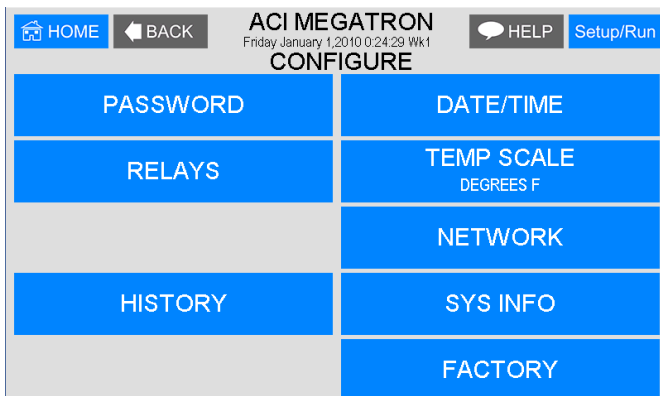

Provides access to menus to set-up passwords, relay activation, temp scale, display contrast, flow switch, inputs, history time stamps, factory set-up and system information.

FLOW SW - Defines a flow switch to be open or closed with flow.
FACTORY - A factory only menu
TEMP SCALE - Set Celsius or Fahrenheit
HISTORY - Sets the history time stamp interval.
SYS INFO - Tells unit software specifics.

4.1 Password

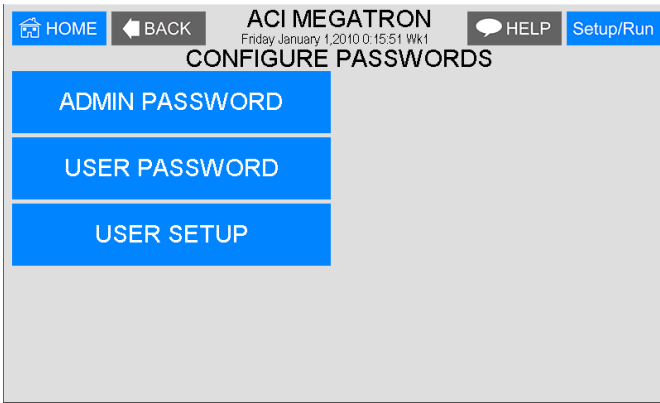

ADMIN PASSWORD - The administrator password gives access to all menus except factory set up.

USER PASSWORD - The user password allows the user to access HOME menus that are made available in USER SET UP.

USER SETUP - The user setup chooses which menus they can access.

4.2 Date and Time Set Up

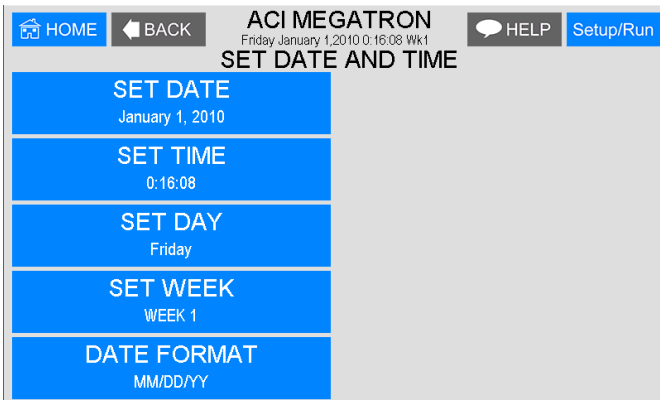

DATE AND TIME - For setting the date, time, day, and week on the controller.

4.3 Relays

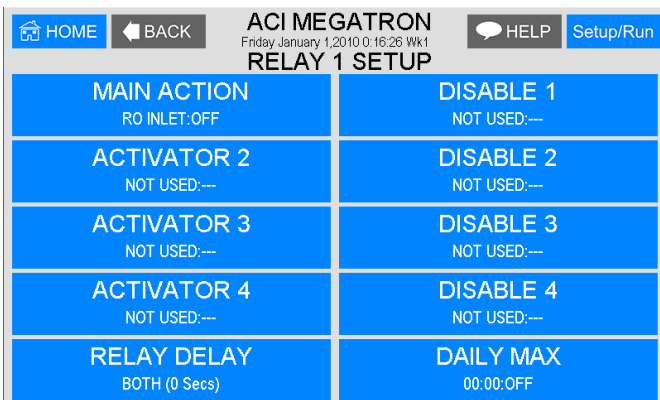

CONFIGURE RELAYS - This menu lets you choose a **Main Action** or function (timer 1, conductivity, alarms etc...) to activate a relay.

A pop-up screen appears with a list of all available activation functions to arrow through.

Additional relay logic is available with up to 3 additional **Activators** and up to 4 **Disablers** allowing multiple functions to activate the same relay and multiple functions to prevent the relay from coming on. There is also a Daily Max amount of time that a relay can be on. If a relay is on for the max amount, it does not let the relay come on anymore that day (a 24-hour clock is used for the day with midnight being the start of the day). The Delay setting is the amount of time a control function must come on before the relay will react and activate. This is to prevent a relay from chattering on/off if a reading is bouncing around the set point or alarm.

4.4 History

This menu is used to set the history “time stamp” interval, the water meter daily history starting hour, the alarm delay period and the USB history save format.

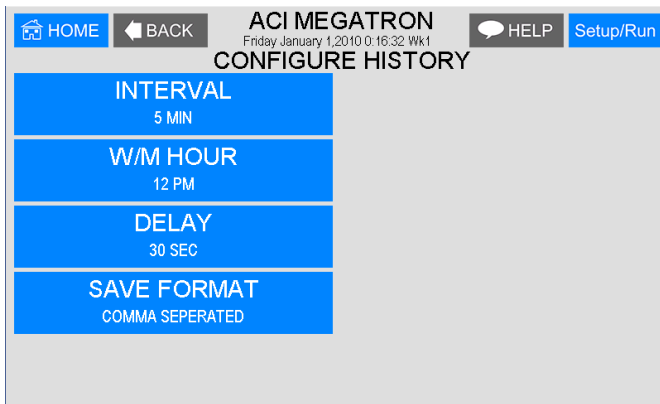

INTERVAL - The amount of time between each history time stamp for probe readings.

W/M HOUR - The time of day that the daily water meter history cycle is to start.

ALARM DELAY - The amount of time an alarm has to be on before it is recognized as an alarm.

SAVE FORMAT - The USB history save format.

4.5 Temperature Scale

This menu is used to select the type of temperature scale to display.

4.6 Network

The Network menu is used when a controller is being remotely communicated with either a local network connection or over the internet on the WebAdvantage server. IP Address, IP Mask, Gateway, and other information can be viewed from this menu.

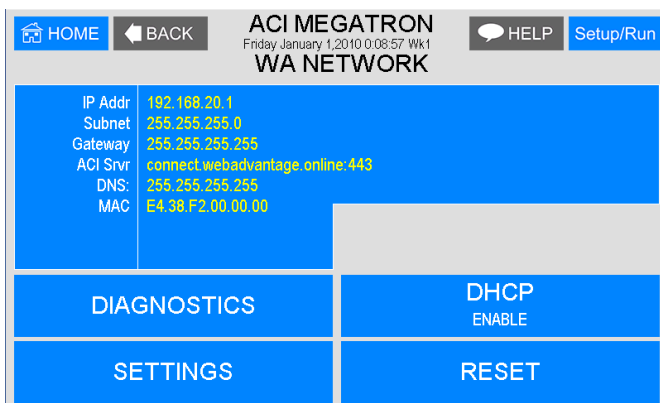

SETTINGS - This menu is used for setting up the remote WebAdvantage communications and is covered in a separate manual.

<http://www.advantagecontrols.com/downloads/pdf/M-WebAdvantage.pdf>

Note: The Network card must be RESET after making any changes to Network setting in order to save changes and reset communications.

4.7 System Information

System information will identify the version of firmware installed in the controller along with the controller's serial number.

5. History

The onboard history allows for viewing the history of the probe readings, relay activations, key-pad activity, calibrations, water meter hourly and daily logs, and alarms for each system present. It is also where Notepad data is entered and reviewed. An initial overview page is displayed showing your current sample interval, the calculated number of days the unit can keep probe history for before losing the oldest. The number of sensor samples and relay/alarm events and Notepad entries currently stored is also displayed.

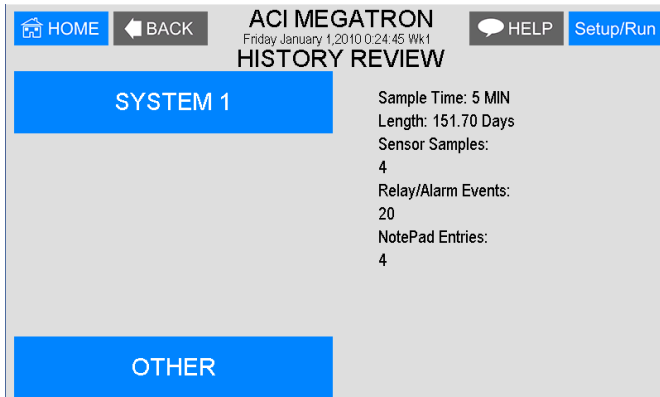

NOTE: The history can be reset by going to the configure menu and entering a different sample interval. After the new sample interval has been set, the onboard history is reset.

5.1 Viewing History

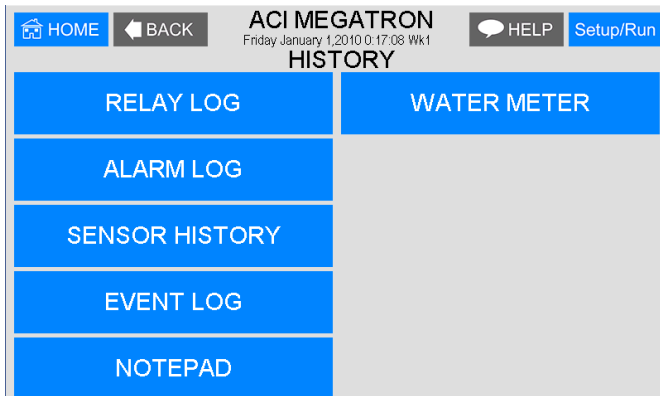

RELAY LOGS - Relay activations displayed in a log form. Arrow up to advance through the log.

ALARM LOG - Alarm activations in log form.

SENSOR HISTORY - For selecting the parameters and viewing of a given probe reading's history in log or graph form.

EVENT LOG - Displays various activities.

NOTEPAD - View and enter notepad history

WATER METER - View system card water meter history

5.2 Notepad Entries

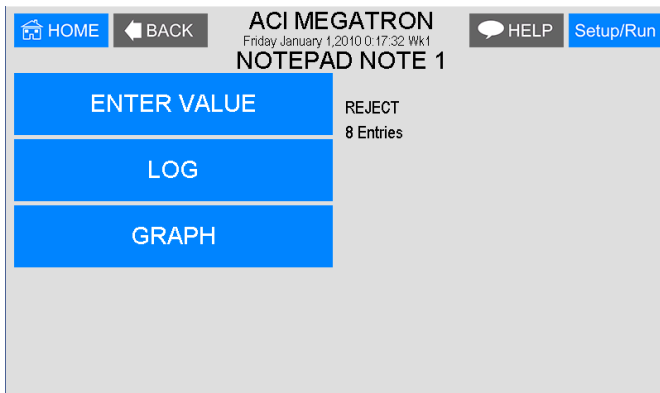

The Notepad section under History is where the user goes to enter new values for the customized notepad items. Each individual notepad item's manually entered entries are stored in the unit's history and can be reviewed in log or graph form after 4 or more values have been entered.

5.3 Water Meter History

The water meter history allows the user to review both water meter one and two of a particular system in both an hourly format (for the past 24 hours) or a daily format for the past 60 days. If an evaporation calculation is being kept, a daily history of this value is also available.

6. Flow Meters

A unit may have up to 5 option auxiliary flow meter inputs. These additional inputs are for tracking various flow meter devices. They can also be linked to a system's water meter input for additional tracking and alarm capabilities.

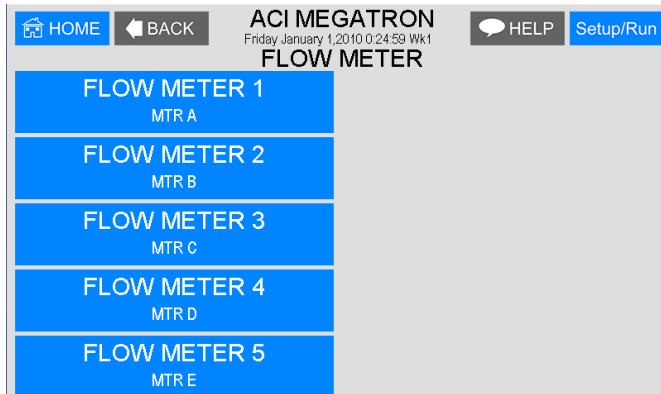

Select the Aux Flow Meter to set-up or review.

6.1 Flow Meter Setup

The Flow Meter setup gives the user access to the various settings for the flow meter along with a review of the current settings.

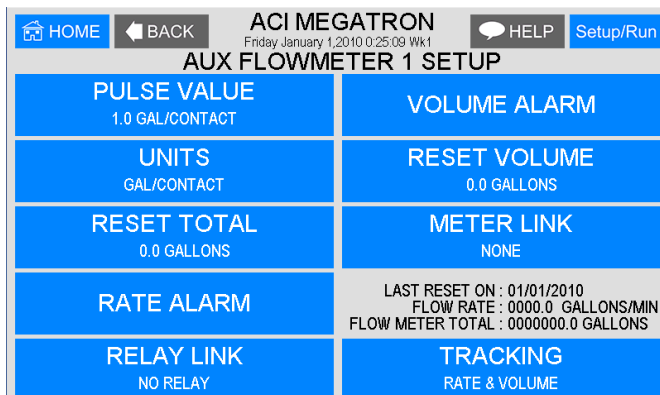

PULSE VALUE - Defines the numerical value for a contact, i.e. 225.

UNITS - Defines the units of measure for a contact, i.e. Pulses / Ounce.

RESET TOTAL - Resets the totalized count of the meter.

RATE ALARM - Setting for excessive flow rate alarming.

RELAY LINK - The relay link informs the Aux meter input is relevant to the control function that the selected

relay is being driven by. For example, if the Aux flow meter is a metering pump's FloTracker then it should be linked to the relay that is driven by the feed timer that pump will be controlled by.

VOLUME ALARM - If FloTracker has been selected as the Tracking method, an alarm will occur when the defined VOLUME USED has passed through the flow device.

Note: If Rate and Volume tracking has been selected an alarm will occur if the defined MAX VOLUME amount is measured within the defined TIME CYCLE which can be a 12- or 24-hour period.

RESET VOLUME - Resets the Volume Alarm totalizer.

METER LINK – This selection only shows if the tracking method is Rate and Volume and tells the auxiliary flowmeter input to get its signals from one of the system water meters already wired to the controller's water meter inputs. If this is selected, no wiring to the auxiliary input is required and the PULSE VALUE and UNITS settings are auto populated from the water meter's settings.

TRACKING - Provides a pop-up screen to select either FloTracker or Rate and Volume tracking.

7. Relays

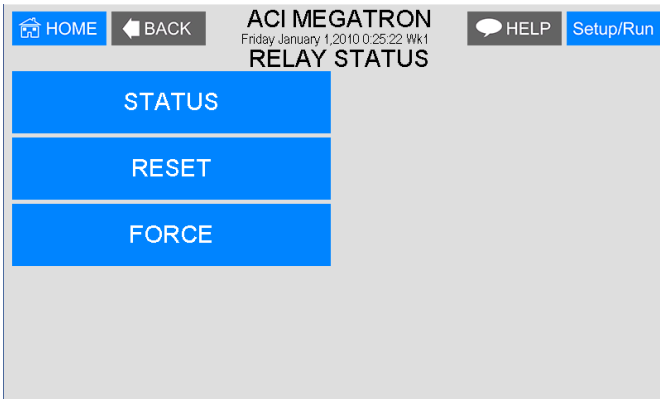

STATUS - Allows for viewing accumulated relay ON times, temporary forcing relays ON or OFF or seeing which relay is on.

RESET - Allows the accumulated run time of a particular relay to be reset to zero.

FORCE - Allows a relay to be manually forced ON or OFF for a single event from 0-999 minutes. When the event is over the relay goes back to its normal automatic control.

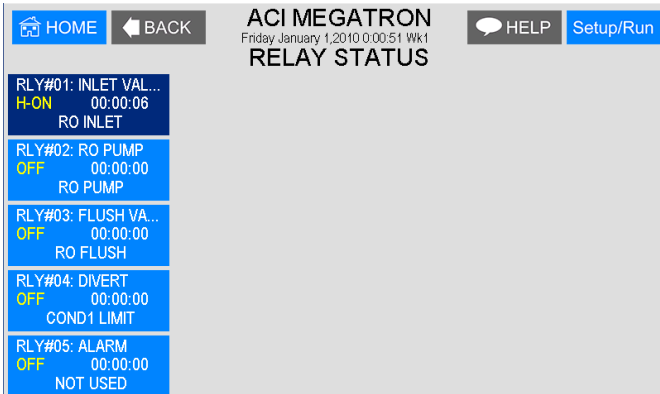

In the STATUS view the accumulated ON time is shown along with the main activator, custom name and current status:

ON = Relay on by relay activators

OFF = Relay off by normal logic

OFF-T = Relay off for daily max

OFF-D = Relay off for relay disabler

ON-A = Relay activated by activator other than main action

H-ON = Relay manually forced on

H-OFF = Relay manually forced off

VI. Maintenance

The only required maintenance for normal uninterrupted operation of your MegaTron MR controller is cleaning of the electrode(s). After initial startup, it is a good idea to clean the electrode frequently until a schedule based on need has been developed. Since each application is unique, it is difficult to estimate the required frequency of cleaning. The first cleaning should take place after about one week of the system being online.

To determine the required cleaning frequency, record the reading on the controller before the electrode is removed for cleaning. After cleaning, record the new reading. If a change is observed in the two readings, the electrode was dirty. The more significant the change, the dirtier the electrode. If no change occurs, cleaning needs to be done less often.

Conductivity Electrode Cleaning Procedure

1. Record the current conductivity reading.
2. Turn off water flow through the electrode loop, bleed pressure from the line and remove electrode.
3. Use a clean cloth and a mild cleaning solution to remove loose dirt etc., from the flat surface of the electrode.
4. If the electrode has deposits such as scale attached to the electrode surface, a more aggressive cleaning approach will be needed. There are several ways to do this, the preferred method being the one that is easiest for the user.
 - a. Use a mild acid solution to dissolve deposits.
 - b. Lay a piece of sandpaper (200 grit or finer) on a flat surface such as a bench top. "Sand" electrode to remove stubborn deposits. Do not wipe the surface with your finger. Oil from your skin will foul carbon tips.
5. Reinstall the electrode in the system. After the reading stabilizes, calibrate the unit to a reliable test reading.

Many times, an electrode can appear to be clean, but the unit still cannot be calibrated. If this is the case, use one of the more aggressive electrode cleaning procedures listed in step 4 above. Recheck the calibration after completion of this procedure. If no change was observed in the reading, replace the electrode. If a change occurred but the unit still will not calibrate, repeat procedure as many times as necessary.

pH and ORP Electrode Cleaning Procedure

1. Remove the pH electrode from the system.
2. Spray with water and/or detergent, using a soft brush to dislodge any fouling.
3. Visually inspect the electrode for signs of damage.
4. Calibrate the electrode while it is in a known solution.

Slow response or non-reproducible measurements are signs that the electrode has become coated or clogged. The pH glass is susceptible to mounting by many substances. The speed of response, normally 95% of the reading in less than 10 seconds, is dramatically degraded when the pH glass is coated.

To restore the speed of response for a pH electrode, clean the bulb with a high-quality detergent, methyl alcohol or other suitable solvent using a Q-tip. Rinse well with distilled water and retest. If the electrode now responds, but erratically, soak the sensor in 0.1 Molar HCl for 5 minutes. Remove and rinse with water and place in 0.1 Molar NaOH for 5 minutes. Remove, rinse again, and then place the sensor in pH 4. buffer for 10 minutes before use.

VII. Advantage Controls Limited Warranty

What the warranty covers:

Advantage Controls warrants the controllers to be free from defects in materials and workmanship during the warranty period. If a product proves to be defective during the warranty period, Advantage controls will repair the unit.

How long the warranty is effective:

The warranty is for one year, and starts the day the product leaves our facility

What the warranty does not cover:

1. Damage, deterioration, or malfunction resulting from:
 - a. Accident misuse, neglect, fire, water lightning or other acts of nature, unauthorized product modification or failure to follow instructions supplied with the product.
 - b. Repair or attempted repair by anyone not authorized by Advantage Controls.
 - c. Any damage of the product due to shipment.
 - d. Causes external to the product such as electric power fluctuations.
 - e. Use of supplies or parts not meeting Advantage Controls' specifications.
 - f. Normal wear and tear.
 - g. Any other cause which does not relate to a product defect.
2. Transportation costs necessary to obtain service under this warranty.
3. Labor other than factory labor.

How to get service:

1. To obtain warranty service, contact Advantage Controls for a Return Material Authorization (RMA).
2. You will be required to provide:
 - a. Your name and address
 - b. A description of the problem
3. Package the controller carefully for shipment and return it to Advantage Controls

Limitation of implied warranties:

There are no warranties, expressed or implied, which extend beyond the description contained herein including the implied warranty of merchantability and fitness for a particular purpose.

Exclusion of damages:

Advantage Controls' liability is limited to the cost of repair or replacement of the product. Advantage Controls shall not be liable for:

1. Damage to other property caused by any defects in the product, damages based upon inconvenience, loss of use of the product, loss of time, loss of profits, loss of business opportunity, loss of goodwill, interference with business relationships or other commercial loss, even if advised of the possibility or such damages.
2. Any other damages, whether incidental, consequential, or otherwise.
3. Any claim against the customer by any other party.

VIII. Related Items

CHIP RO Controller

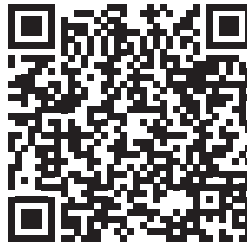

CHIP Manual

ROC-2HE RO Controller

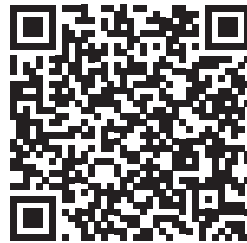

ROC-2HE Manual

ROC-3HE RO Controller



ROC-3HE Manual

ROC-5 RO Controller

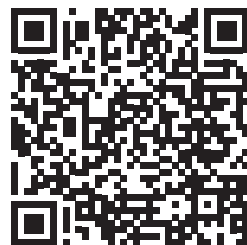

ROC-5 Manual

Get the Advantage in Water Treatment Equipment

Advantage Controls can give you the *Advantage* in products, knowledge, and support for all of your water treatment equipment needs.

- Cooling Tower Controllers
- Boiler Blow Down Controllers
- Blow Down Valve Packages
- Solenoid Valves
- Water Meters
- Chemical Metering Pumps
- Corrosion Coupon Racks
- Chemical Solution Tanks
- Solid Feed Systems
- Feed Timers
- Filter Equipment
- Glycol Feed Systems
- Pre-Fabricated Systems

