

Free Chlorine Sensor

Installation *Maintenance* *Troubleshooting* *Manual*

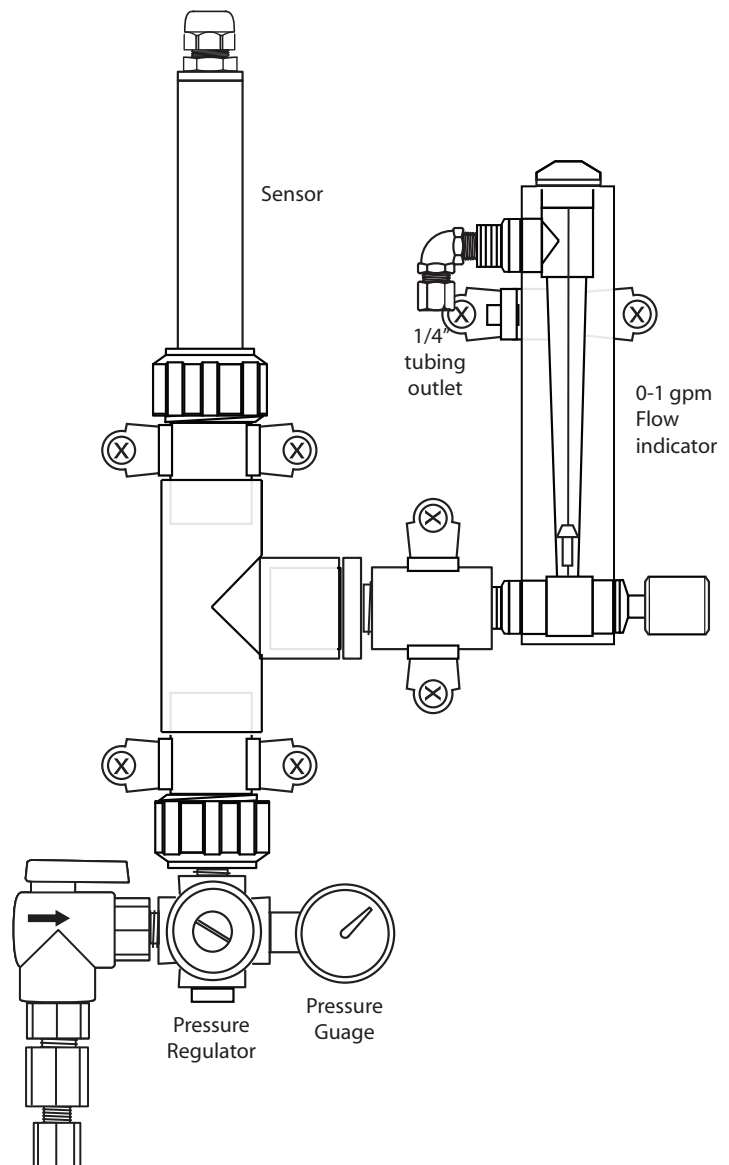

Advantage Controls
P.O. Box 1472
Muskogee, OK 74402
Phone: 800-743-7431
Fax: 888-686-6212
www.advantagecontrols.com
email: support@advantagecontrols.com

9/2016

Free Chlorine Sensors

Instruction & Maintenance Manual

Table of Contents

Contents	Page
I. Theory of Operation.....	3
1.0 Free Chlorine Defined.....	3
1.1 Sensor Operating Principle.....	3
II. Factors Influencing the Sensor.....	3
2.0 pH.....	3
2.1 Chemical Interferences.....	3
2.2 Flow.....	3
2.3 Pressure.....	3
III. Sensor Preparation.....	4
3.0 Free Chlorine Sensor Assembly.....	4
IV. Flow Cell/Flow Meter Installation.....	4
4.0 Flow Cell.....	4
4.1 Flow Meter.....	4
V. Sensor Installation.....	4
5.0 Sensor Installation into Flow Cell.....	4
VI. Electrical Installation.....	5
VII. Sensor Conditioning.....	6
VIII. Calibration.....	6
8.0 Span/Slope Conditioning.....	6
IX. Sensor Storage.....	6
X. Sensor Maintenance/Reconditioning.....	7
10.0 Membrane Cap Replacement.....	7
10.1 Electrolyte Solution Replacement.....	8
10.2 Membrane Replacement.....	8
10.3 Membrane Cap/Sensor Cleaning.....	8
XI. Cathode Polish.....	8
11.0 Removing Oxidation from Gold Cathode.....	8
XII. Sensor Troubleshooting.....	10
12.0 Calibration Problems.....	10
XIII. Warranty & 30 Day Billing Memo Policy.....	11

I. Theory of Operation

1.0 Free Chlorine Defined

Free Chlorine or “freely active chlorine” is defined as the sum of molecular chlorine (Cl_2), hypochlorous acid (HOCl) and hypochlorite ions (OCl^-). Molecular chlorine occurs at pH values $< pH 4$. Hypochlorous acid and hypochlorite ions are in pH dependent equilibrium with one another. Hypochlorous acid is a much stronger disinfecting agent (oxidizer) as compared to hypochlorite ions.

1.1 Sensor Operating Principle

Only hypochlorous acid (HOCl) diffuses through the membrane between the cathode and sample solution. At the applied potential, only hypochlorous acid is electrochemically reduced. HOCl is reduced to chloride ion at the gold cathode. At the same time, the silver anode is oxidized to form silver chloride ($AgCl$). When the concentration of HOCl at the cathode is dramatically decreased by electrochemical reduction, hypochlorite ion will be transformed into hypochlorous acid, and to some extent, by proton transfer. The release of electrons at the cathode and acceptance at the anode creates a current flow, which under constant conditions, is proportional to the free chlorine concentration in the medium outside the sensor. The resulting low current output is then conditioned to 4-20mA current by the sensor’s onboard electronic circuitry.

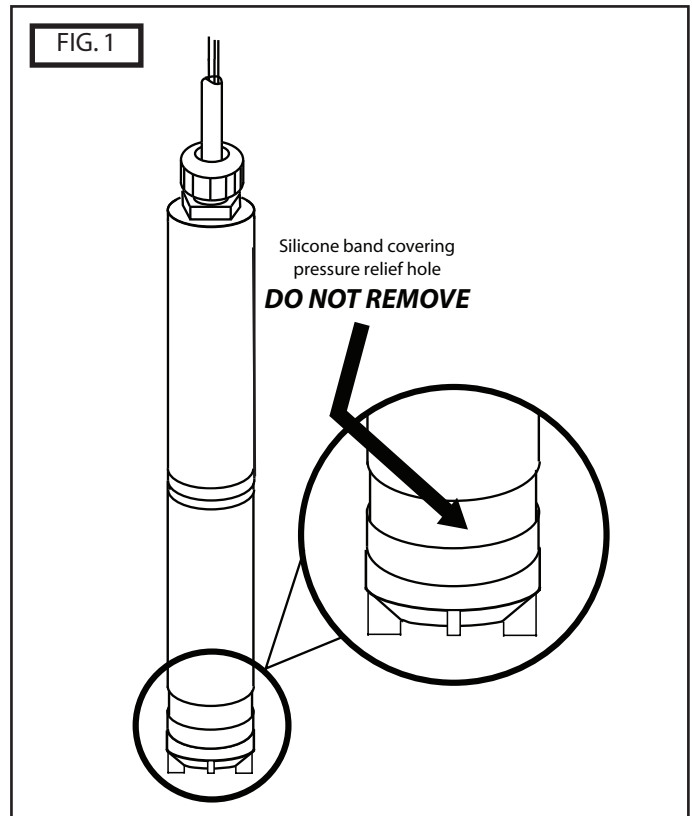

II. Factors Influencing the Sensor

2.0 pH

Free Chlorine (FCL) exists as hypochlorous acid and hypochlorite anion. The acid-base dissociation of FCL has a pK_a of approximately 7.5. The FCL sensor responds to hypochlorous acid and hypochlorite anion with different sensitivity. In combination, an increase in pH reduces the measured FCL and decrease in pH increases the measured FCL. For the most accurate free chlorine measurement, keep system pH at < 6.5 .

2.1 Chemical Interferences

The sensor should not be used in water containing surfactants. Monochloramine and ozone are interferences.

2.2 Flow

To achieve reproducible measurements, the FCL sensors require a specified constant flow rate. To avoid complications (such as bubbles), it is best to operate the sensors at a flow rate of 0.2 - 0.6 gpm.

2.3 Pressure

Pressure is relieved via a small vent hole covered with a silicone sleeve (FIG1). DO NOT REMOVE THE SLEEVE, even when refilling the sensor.

III. Sensor Preparation

3.0 Free Chlorine Sensor Assembly

Your Free Chlorine Sensor is shipped with a protective tube covering the cathode. Remove the tube per FIG. 1A, page 1. It is also shipped with 2 membrane cap assemblies, 2 replacement pressure relief band, 3 sheets of polishing paper and 2 bottles of electrolyte. First, fill the sensor with electrolyte using the provided needle and syringe (FIG. 8). Next place a few drops of electrolyte into the cap (FIG 1b) and then screw on the membrane cap assembly (FIG. 1C). Next install sensor into flow cell per SECTION 5. 0. **NOTE: If sensor will be stored out of flow cell, the internal fill solution should be removed. Take the membrane cap and immerse in a cup of tap water until ready to reuse. See Section 10. Replace cap and electrolyte before installing into flow cell (See section 10 for cap and electrolyte change and see section 5 for sensor installation into flow cell).**

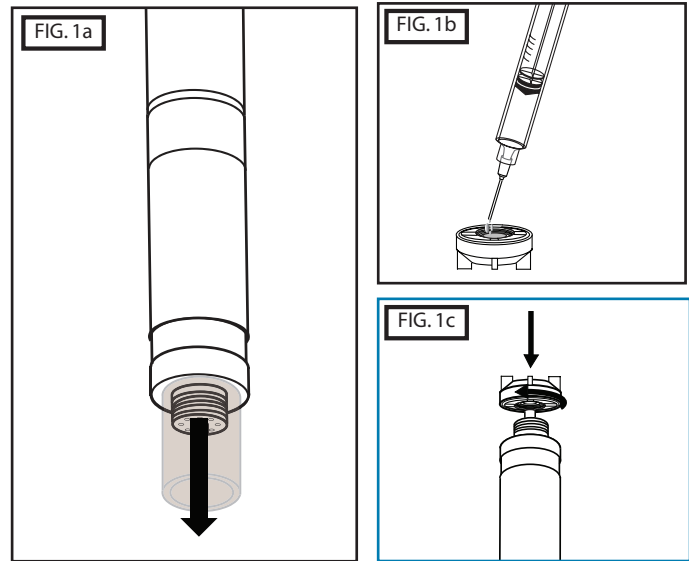

IV. Flow Cell/Flow Meter Installation

4.0 Flow Cell

To obtain accurate Free Chlorine readings, the Sensor must be installed into the Flow Cell to prevent air bubbles formation on the membrane while maintaining proper spacing between the sensor and the installation wall, and laminar flow across the membrane. Make sure sensor and flow cell are oriented vertically.

4.1 Flow Meter

To control flow to the flow cell, a flow meter is recommended. Advantage supplies model WG-FLOW for this purpose. The WG-FLOW provides flow control from 0.1 to 1.0 GPM (0.5 to 4.0 LPM) with 94% accuracy.

V. Sensor Installation

5.0 Sensor Installation into Flow Cell

Install sensor assembly into top of flow cell then turn on flow and verify the flow through the Flow Cell is at least 0.2 gpm (45 liters/hour and no more than 0.6gpm (135 liters/hour).

VI. Electrical Installation

6.0 Electrical Installation

The sensor produces an approximate output of 4 mA in air and 20 mA at the top range of free chlorine output (0-2ppm, 0-5ppm and 0-10ppm).

NOTE: The supply voltage to the Sensor must be 12-24 V DC with minimum of 250 mA. Maximum load is 1 Watt. The sensor has 2 wires, red (+), black (-). See FIG 3. The Sensor will require several minutes to stabilize after power is supplied to it.

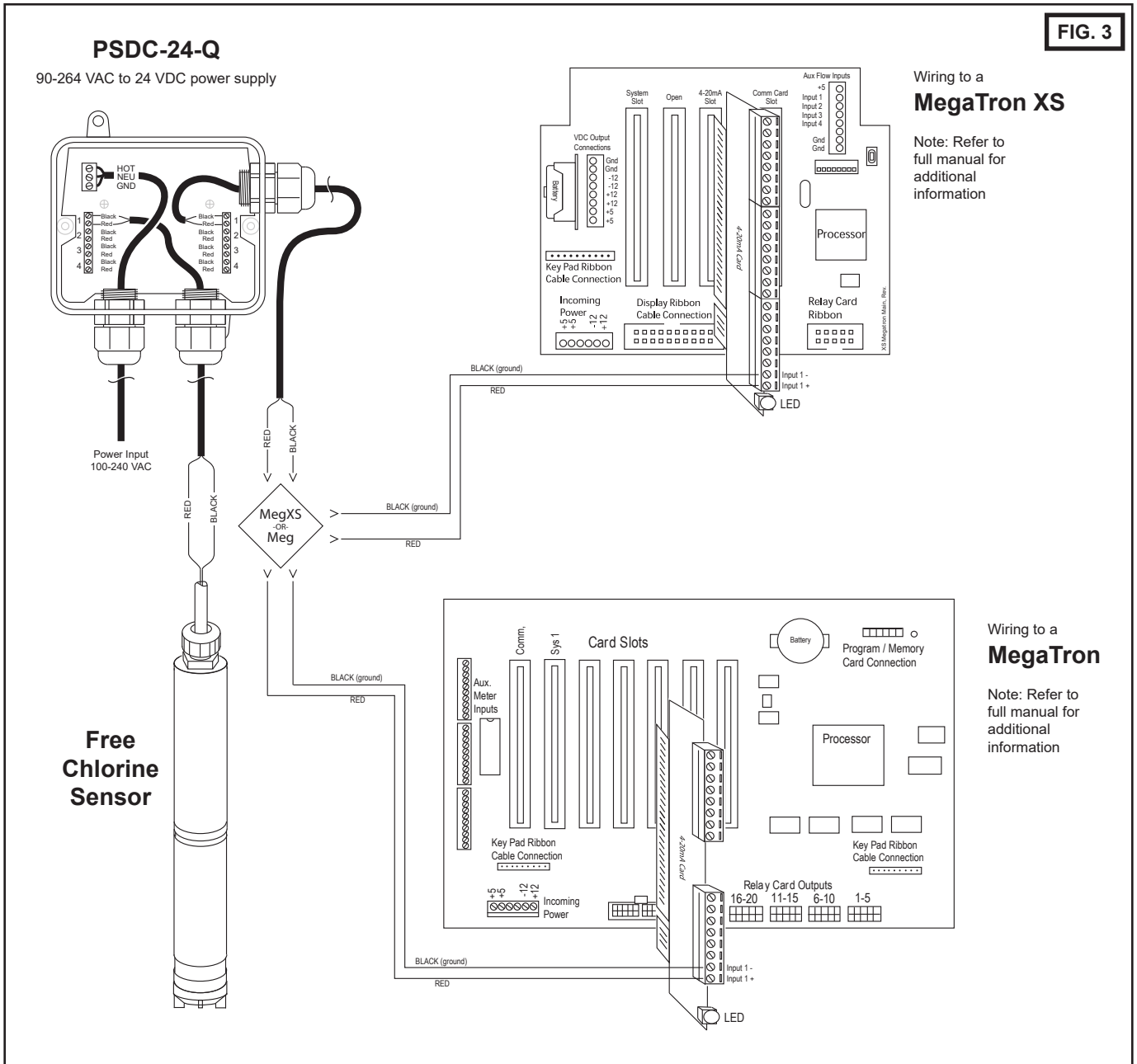

VII. Sensor Conditioning

7.0 Sensor Conditioning

The sensor requires conditioning prior to generating stable values.

- For new Sensors, connect the sensor to power and allow to run overnight (at least 12 hours) before calibration.
- If the Sensor will be un-powered for two hours or more, run for two hours prior to use.
- If the Sensor's flow will be off for one hour or less, run the sensor for at least one hour prior to recalibration.
- After membrane/electrolyte replacement, allow the Sensor to run powered overnight (at least 12 hours) before calibration.

VIII. Calibration

Note: Sensors are supplied factory calibrated with a 4-20mA signal output corresponding to their specific range (0-2, 0-5 OR 0-10ppm). Any span/range calibration can be done at your PLC or other 4-20mA input device. The zero-point calibration is not necessary since the zero setting is very stable. Check calibration at least once per week. There is no need to calibrate if it has not changed much. If calibration is required it should also be done at the PLC or other 4-20mA input device.

8.0 Span/Slope Calibration

- Determine the free chlorine content using a diethyl-p- phenylenediamine (DPD) colorimeter test kit (SEE FIG 4) not included with the sensor and flow cell.
- Measure free chlorine content with sensor. Make sure that calibration flow rate matches flow rate when measuring sample since probe output is flow rate dependent. Make sure pH is within 5.5-8.5 range.
- Adjust span/slope at PLC/4-20mA device.
- Repeat this slope calibration one day after sensor is initially installed.
- Repeat the slope calibration weekly.

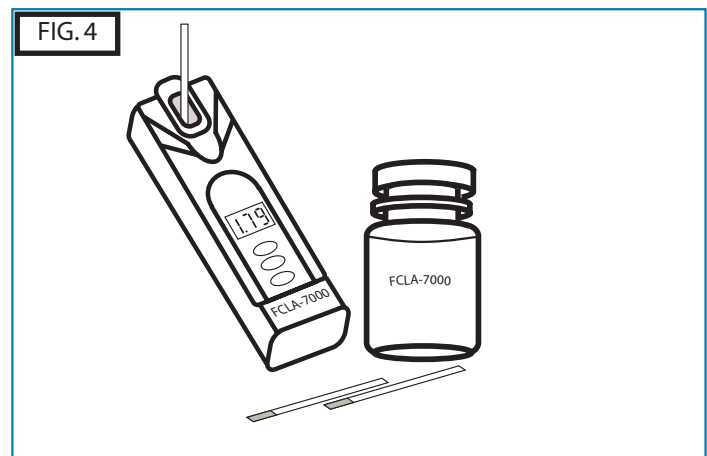

IX. Sensor Storage

Store sensor at 5° C - 50° C only and maximum humidity of 95% non-condensing.

9.0 Storage

- Short Term Storage (one week or less):* Store in Flow cell with water to prevent the probe from drying out.
- Intermediate Term (one week to one month):* Store with cap on sensor in a beaker with water to keep membrane wet.
- Long Term (one month or longer):* Remove Membrane Cap and store cap completely immersed in tap water. Remove fill solution and pour down drain.

Note: Electrolyte shelf life is one year from date of mfg (see bottle).

X. Sensor Maintenance/Reconditioning

10.0 Membrane Cap Replacement

If membrane replacement is required, a new cap with preinstalled membrane must be used. Two caps and 2 bottles of refill solution are shipped with each sensor. Additional caps and refill are ordered as solution WG-FCLA-5018.

To change membrane cap:

- Turn sensor upside down with cap facing upward.
- Rotate cap counter-clockwise to remove (SEE FIG 5).
- Place needle tip on syringe as shown in FIG 6.
- Remove solution from bottle with needle and syringe (FIG 7).
- Fill sensor body with electrolyte using needle and bottle of refill solution until it flows out of the holes near the cathode(SEE FIG 8).
- Add a few drops of electrolyte to the membrane cap (FIG 9).
- Install new membrane cap by threading cap onto sensor rotating cap clockwise (Opposite of FIG 5).

DO NOT TOUCH THE CATHODE DURING THIS PROCESS SINCE IT CAN BE DAMAGED.

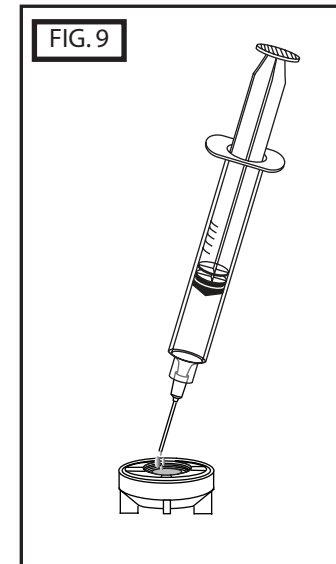
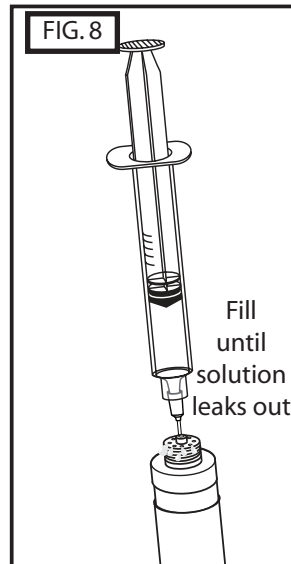
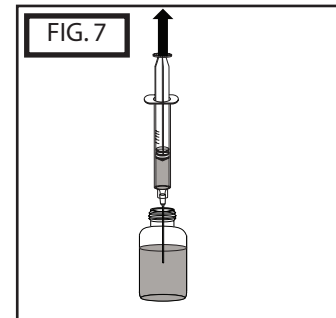
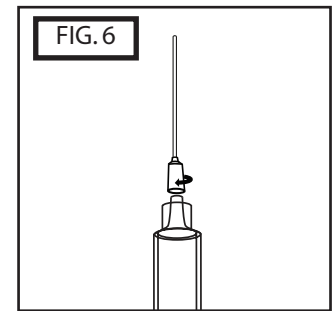
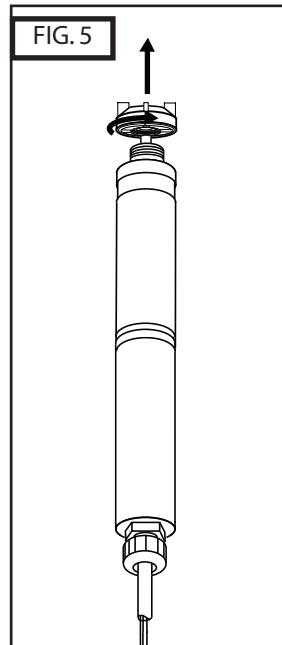

10.1 Electrolyte Solution Replacement

Drain old refill solution and pour down drain. Refill the sensor approximately every two months.

10.2 Membrane Replacement

If membrane replacement is required (change at least every 6 months), a new cap with preinstalled membrane must be used. 2 caps and 2 bottles of fill solution are shipped with each sensor. Additional caps and refill solution as WH-FCLA-5018.

To change membrane cap:

- a) Turn sensor upside down with cap facing upward.
- b) Rotate cap counter-clockwise to remove (SEE FIG 5).
- c) Attached supplied needle to syringe and remove fill solution as shown in FIG 6 & FIG 7.
Electrolyte is safe and can be poured down the drain.
- d) Fill sensor body with electrolyte using needle and syringe of refill solution (SEE FIG 8).
- e) Add a few drops of electrolyte to the membrane cap (FIG 9).
- f) **DO NOT TOUCH THE CATHODE DURING THIS PROCESS SINCE IT CAN BE DAMAGED.**
- g) Install a new membrane cap by threading cap onto sensor rotating cap clockwise (FIG 1B).

10.3 Membrane Cap/Sensor Cleaning

Rinse cap with water only. If cap does not clean, replace with new one.

XI. Cathode Polish

If the sensor cannot calibrate, then the gold cathode could be coated. Follow instruction in cathode polishing addendum to this instruction manual. Then fill the sensor and replace membrane cap assembly. Allow 4 hours before repowering sensor and attempting calibration again.

11.0 Removing oxidation from FCL and CLD sensor's gold cathode

- a) If it is not possible to perform correct calibration after replacing the bottom cap and electrolyte, then the cause may be oxidation of the gold electrode. This oxidation will notably reduce the performance of the sensor and must be removed.
- b) Make sure to wear rubber gloves and protective eye wear when servicing the sensor because the electrolyte is a strong acid (FIG. 10).
- c) Hold or clamp the sensor vertically so that the bottom cap is pointing up (FIG. 11).
- d) Unscrew the bottom cap (FIG. 11) and dry the internal electrode using a clean dry cloth (FIG. 12). Be careful not to rub the gold surface because it is easily scratched.
- e) Using the supplied abrasive paper (shiny side up) place it on the gold cathode and lightly rub it with your index finger using a circular motion (FIG. 13).
- f) Move the abrasive paper slightly as you rub the cathode to continuously expose new abrasive material. It does not take a lot of force, but continue to rub in a circular pattern for about a count of 60. Note the surface is domed and needs to stay this way – do not put a flat on the cathode.
- g) Check that the oxidation has been removed. The oxide layer is not easy to see, but the gold cathode should look brighter and shinier than before (FIG. 14). If necessary, repeat the operation using the abrasive paper.

- h) Soak a Q-tip with fresh electrolyte and lightly wipe the electrode surface to clean off debris. Use only light pressure as the gold surface can be easily damaged. (FIG. 15).
- i) Top off the electrolyte with the syringe and needle so as to flush out any contaminants that may have dropped into the holes and the adjacent surface. If the cap is new and in good shape, add a few drops of electrolyte to the inside of the membrane pocket (FIG. 16), then screw it slowly back on to the sensor. **Catch any electrolyte that runs from under the cap with a towel.**
- j) Install sensor back into flow cell and start flow. Apply power to sensor for at least 4 hours before calibrating.

ONLY USE THE ABRASIVE PAPER SUPPLIED. OTHER TYPE OF ABRASIVE PAPER COULD CAUSE SERIOUS DAMAGE TO THE GOLD ELECTRODE.

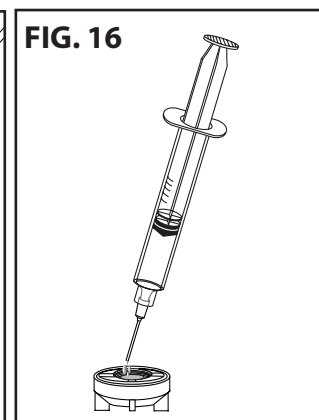
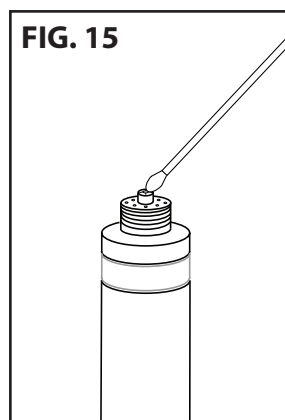
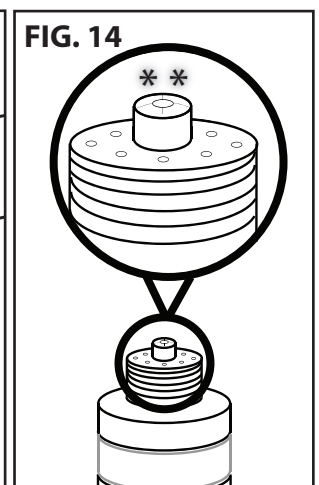
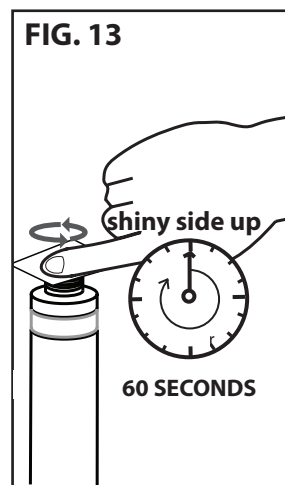
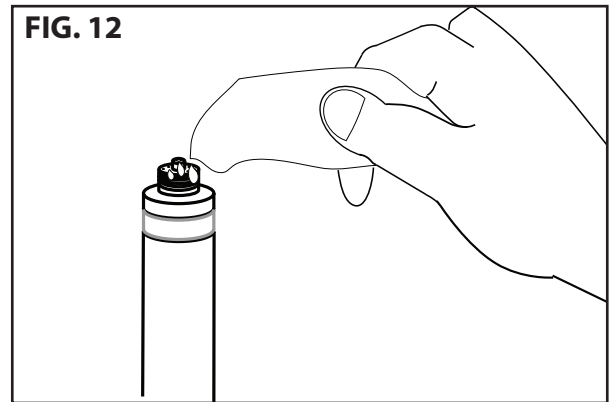
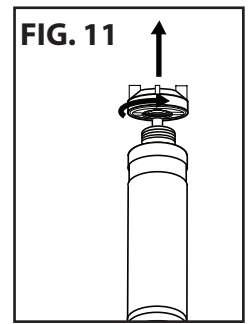

XII. Sensor Troubleshooting

12.0 Calibration Problems

A. Sensor output *higher* than DPD test

- 1) Run in time too short
- 2) Membrane cap damaged
- 3) Interference from water contaminants (see Specifications, "Cross Sensitivity")
- 4) Cable short circuit or damage
- 5) pH value less than pH 5.5

B. Sensor output *lower* than DPD test

- 1) Run in time too short
- 2) Deposits on Membrane cap
- 3) Flow rate too low
- 4) Air bubbles on membrane
- 5) Surfactants in water
- 6) pH value more than pH 8.5
- 7) No electrolyte in sensor chamber
- 8) Cathode coated

C. Sensor output is 4mA (zero ppm)

- 1) Run in time too short
- 2) Only bound chlorine present
- 3) Chlorine content below detection limit
- 4) Sensor not wired correctly
- 5) Defective sensor

D. Sensor output *unstable*

- 1) Air bubbles on membrane
- 2) Membrane damage
- 3) Pressure fluctuation in sample line.

TROUBLESHOOTING CHART

Symptom	Possible Cause	Solution/Remedy
The sensor cannot be calibrated- output is <i>HIGHER</i> than	<ol style="list-style-type: none"> 1) Run in time too short 2) Membrane cap damaged 3) Interference from contaminants 4) DPD chemicals bad 5) Temperature increased since cal 	<ol style="list-style-type: none"> 1) See Sec 7.0 -CONDITIONING 2) Replace cap - See Sec 11.0 3) See SPECIFICATIONS 4) Use new DPD kit 5) Match calibration temp.
The sensor cannot be calibrated- output is <i>LOWER</i> than DPD Test	<ol style="list-style-type: none"> 1) Run in time too short 2) Deposits on membrane cap 3) Flow rate too low 4) Air bubbles on membrane 5) Surfactants in water 6) No electrolyte in cap 8) Temperature decreased since cal 9) Cathode coated 	<ol style="list-style-type: none"> 1) See Sec 7.0 -CONDITIONING 2) Remove deposits or replace cap if cleaning ineffective. 3) increase flow - See SPECIFICATIONS 4) Remove and re-install sensor to remove bubbles. 5) Remove surfactants and replace cap. See SEC 11.0 6) Add new electrolyte, run in sensor and re-calibrate 8) Increase temp to match cal 9) Polish cathode per Sensorex instructions. This should only be done if electrolyte refill and membrane cap change have not improved sensor performance.
Sensor output is 4mA (0ppm)	<ol style="list-style-type: none"> 1) NO Free chlorine present 2) Run in time too short 3) Free chlorine concentration low 4) No electrolyte in cap 5) Sensor electrical connection wrong 	<ol style="list-style-type: none"> 1) Check system. 2) See Sec 7.0 -CONDITIONING 3) Add free chlorine and repeat calibration 4) Refill electrolyte 5) See SECTION 6.0
Unstable output from sensor	<ol style="list-style-type: none"> 1) Air bubbles on sensor membrane 2) Membrane damaged 3) Non-sensor problem 	<ol style="list-style-type: none"> 1) Tap to remove bubbles 2) Replace membrane, run in sensor and recalibrate. 3) check PLC or I/O device

XIII. Advantage Controls' Product Warranty

Advantage Controls warrants control systems of its manufacture to be free of defects in material or workmanship. Liability under this policy extends for 24 months from date of installation. Liability is limited to repair or replacement of any failed equipment or part proven defective in material or workmanship upon manufacturer's examination. Removal and installation costs are not included under this warranty. Manufacturer's liability shall never exceed the selling price of equipment or part in question.

Advantage disclaims all liability for damage by its products caused by improper installation, maintenance, use or attempts to operate products beyond their intended functionality, intentionally or otherwise, or any unauthorized repair. Advantage is not responsible for damages, injuries or expenses incurred through the use of its products.

The above warranty is in lieu of other warranties, either expressed or implied. No agent of ours is authorized to provide any warranty other than the above.

30 Day Billing Memo Policy

Advantage Controls maintains a unique factory exchange program to ensure uninterrupted service with minimum downtime. If your controller malfunctions, call 1-800-743-7431, provide our technician with Model and Serial Number information. If they are unable to diagnose and solve your problem over the phone, a fully warranted replacement will be shipped, usually within 48 hours, on a 30 Day Billing Memo.

This service requires a purchase order and the replacement is billed to your regular account for payment.

The replacement will be billed at current list price for that model less any applicable resale discount. Upon return of your old panel, credit will be issued to your account at either 100% if your unit is in warranty or at 50% if your unit was out of warranty. The exchange covers only the panel. Electrode and enclosure are not included.

FCC Warning

This equipment generates and uses radio frequency energy and if not installed and used properly, that is, in strict accordance with the manufacturer's instruction, may cause interference to radio communications. It has been type tested and found to comply with the limits for a class A computing device pursuant to subpart J of part 15 of FCC Rules, which are designed to provide reasonable protection against such interference when operated in a commercial or industrial environment. Operation of this equipment in a residential area is likely to cause interference in which case the user, at his own expense, will be required to take whatever measures necessary to correct the interference.

Get the Advantage in Water Treatment Equipment

Advantage Controls can give you the *Advantage* in products, knowledge and support on all of your water treatment equipment needs.

- Cooling Tower Controllers
- Boiler Blow Down Controllers
- Blow Down Valve Packages
- Solenoid Valves
- Water Meters
- Chemical Metering Pumps
- Corrosion Coupon Racks
- Chemical Solution Tanks
- Solid Feed Systems
- Feed Timers
- Filter Equipment
- Glycol Feed Systems
- Pre Fabricated Systems

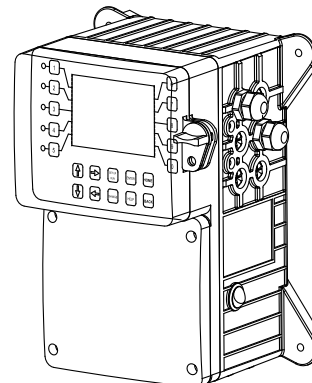
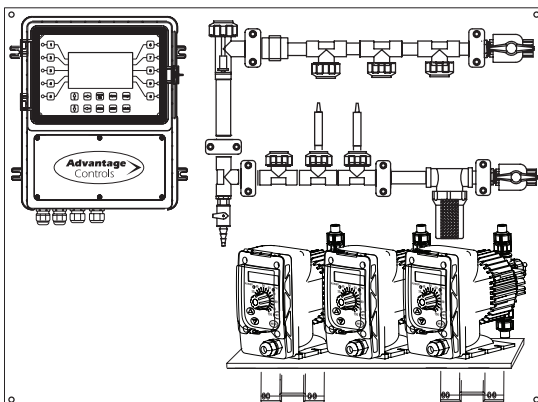
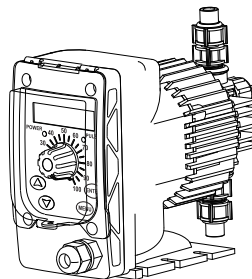
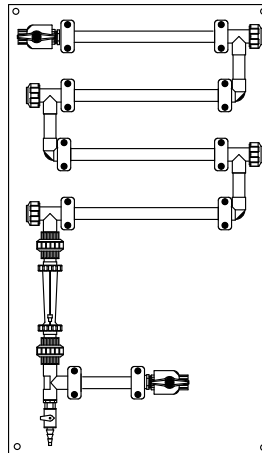
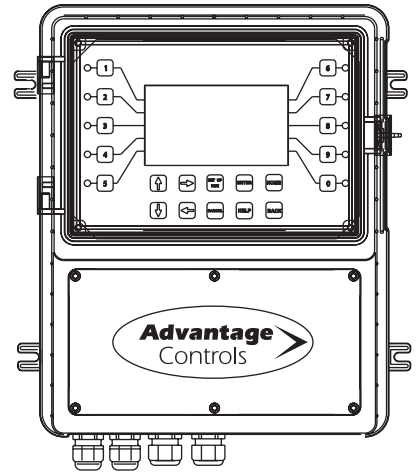
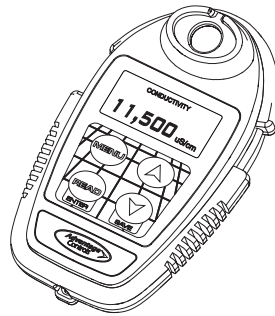

Get the Advantage

Advantage
Controls